

# **WHELEN<sup>®</sup>**

**ENGINEERING COMPANY INC.**

*51 Winthrop Road*

*Chester, Connecticut 06412-0684*

*Phone: (800) 63SIREN*

*Phone: (860) 526-9504*

*Fax: (860) 526-4784*

*Internet: [www.whelen.com](http://www.whelen.com)*

*Sales e-mail: [iowsales@whelen.com](mailto:iowsales@whelen.com)*

*Customer Service e-mail: [iowserv@whelen.com](mailto:iowserv@whelen.com)*

# **VORTEX™ SERIES SIREN SYSTEM**

## **INSTALLATION, OPERATING & TROUBLESHOOTING MANUAL**

**Mass Notification**

***For warranty information regarding this product, visit [www.whelen.com/warranty](http://www.whelen.com/warranty)***

# Table Of Contents

## Chapter 1: Installation

<b>An Important Note To Installation Technicians .....</b>	<b>page 7</b>
<b>Section I: Site Selection.....</b>	<b>page 9</b>
<b>Section II: Utility Pole Preparation .....</b>	<b>page 10</b>
a) Pole Selection.....	page 10
b) Component Dimensions .....	page 10
<b>Section III: Equipment Mounting .....</b>	<b>page 14</b>
a) Pole Top Bracket Installation .....	page 14
b) Electronic Cabinet Mounting and Siren Connections.....	page 16
c) Siren Assembly Mounting .....	page 18
d) Antenna Mounting (optional).....	page 20
e) Solar Panel Mounting (optional) .....	page 21
f) Determining Solar Panel Mounting Angle.....	page 24
<b>Section IV: Wiring.....</b>	<b>page 25</b>
a) Speaker/Rotator Wiring.....	page 25
b) AC Wiring .....	page 26
c) Batteries .....	page 28
d) Landline (optional) .....	page 29
e) Two-Tone (optional).....	page 30
f) Aux-In (optional) .....	page 31
<b>Section V: System Test .....</b>	<b>page 32</b>

## Chapter 2: Operation

<b>Section VI: Overview of System Components .....</b>	<b>page 35</b>
a) Station Component Locations.....	page 35
b) Station Components Defined .....	page 36
<b>Section VII: System Operations.....</b>	<b>page 38</b>
a) Remote Operations .....	page 38
b) Local Operations.....	page 38
<b>Section VIII: Understanding Station Addressing.....</b>	<b>page 40</b>
a) Central Point Source: Quadrant, Sector, Radial & Station .....	page 40
b) Governmental: County, City & Station .....	page 46

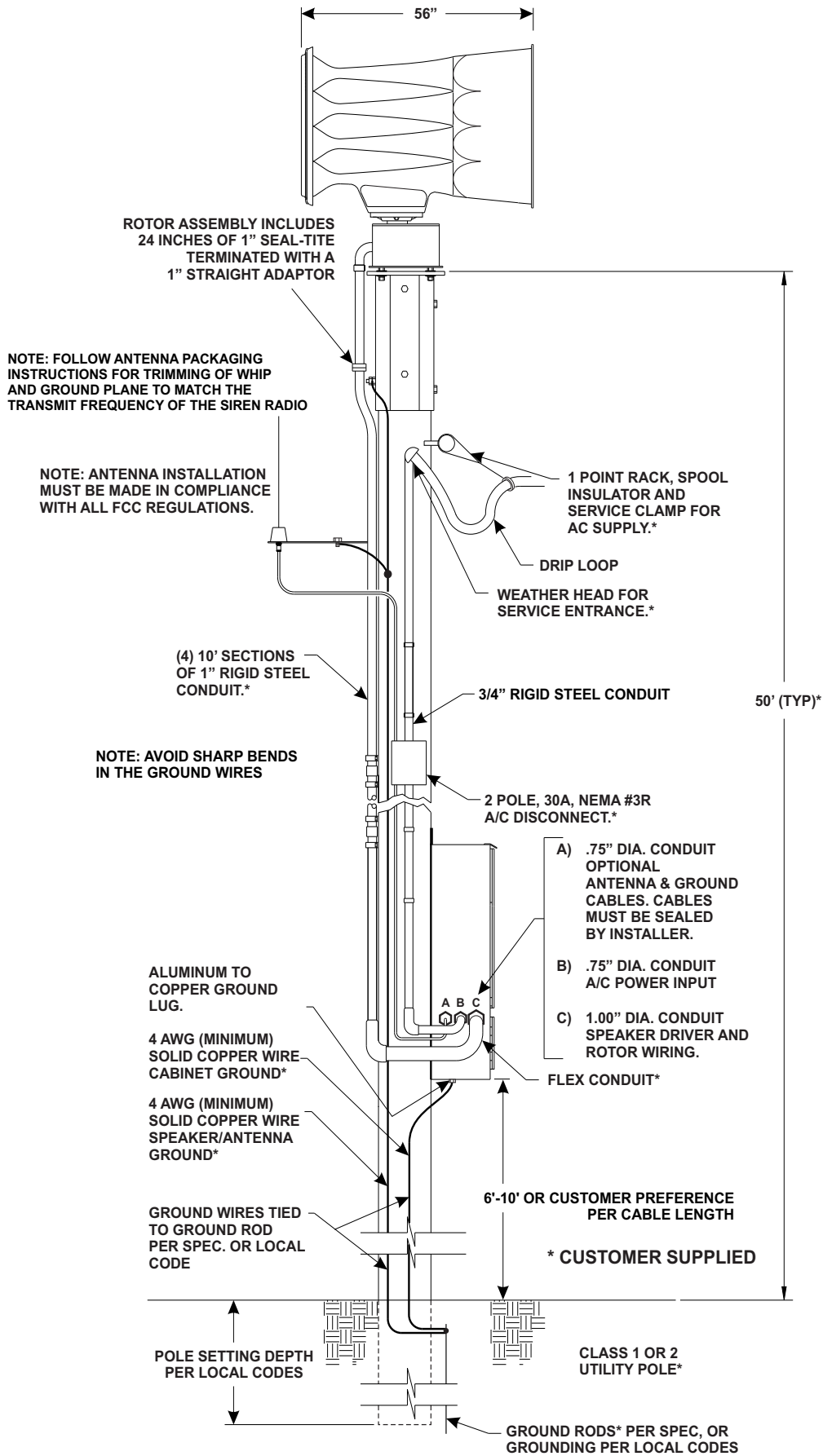
## Chapter 3: Troubleshooting

<b>Section IX: Troubleshooting</b> .....	<b>page 48</b>
a) Audio Loss.....	page 48
b) AC Battery Charger.....	page 49
c) Solar Regulator .....	page 49
d) Partial or Full Diagnostic Failure.....	page 50
<b>Section X: Maintenance</b> .....	<b>page 51</b>
a) Frequency of Testing and Activation.....	page 51
b) Local Site Confirmation .....	page 51
c) Remote monitoring and Confirmation .....	page 52
d) Quarterly Maintenance .....	page 52
e) Visual Siren Station Physical Inspection .....	page 53
f) Siren Cabinet and Components.....	page 53
g) Speaker Assembly and Pole Top Equipment.....	page 53
h) Station Performance Testing .....	page 54
<b>Maintenance Check List</b> .....	<b>page 56</b>

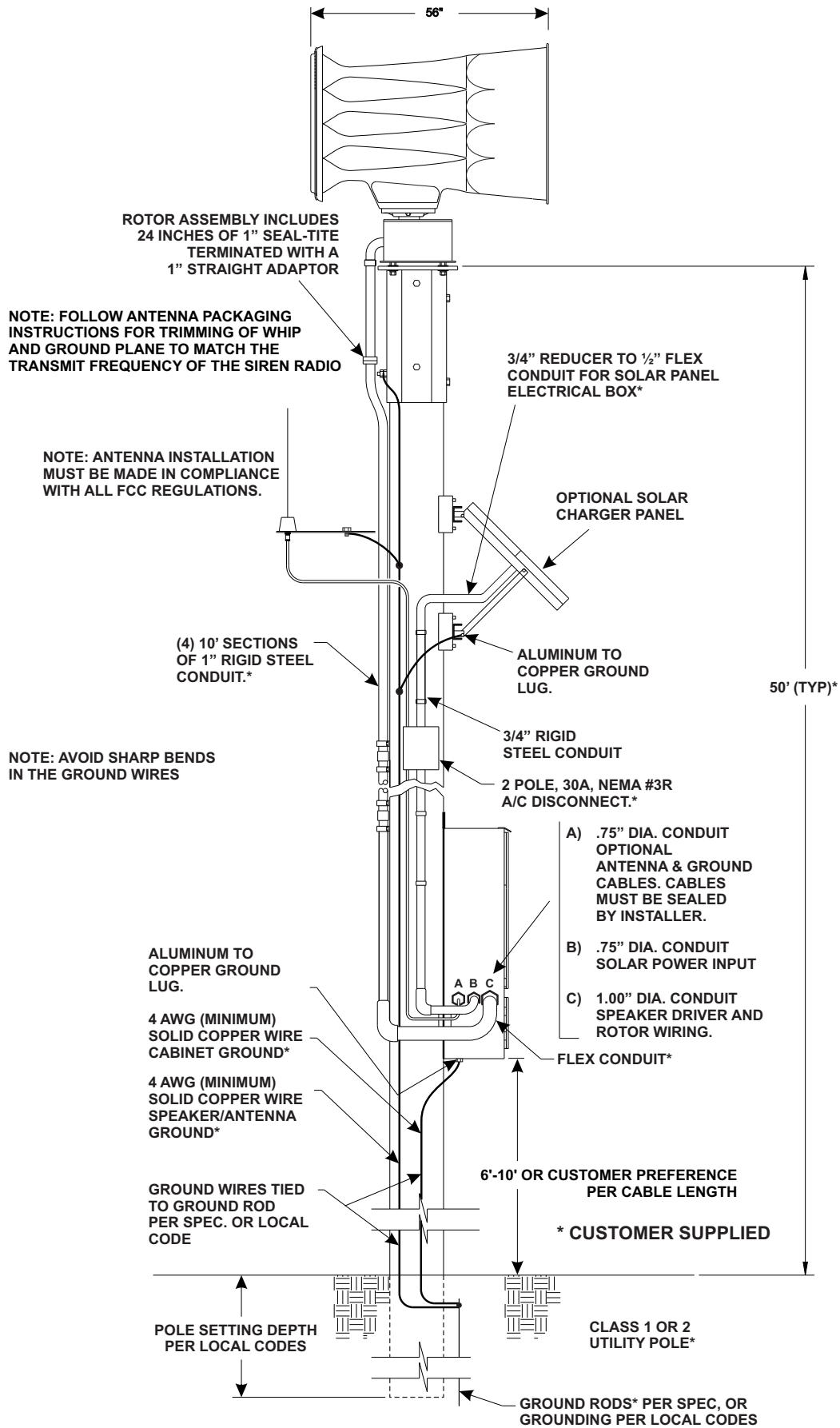
## Illustrations

<b>Fig. 1: Sample Station Drawing (AC Powered Battery Charger)</b> .....	<b>page 4</b>
<b>Fig. 2: Sample Station Drawing (Optional Solar Powered Battery Charger)</b> .....	<b>page 5</b>
<b>Fig. 3: Pole Top Mounting Bracket Dimensions</b> .....	<b>page 11</b>
<b>Fig. 4: Electronic Cabinet Dimensions</b> .....	<b>page 12</b>
<b>Fig. 5: Antenna Mounting Bracket Dimensions</b> .....	<b>page 13</b>
<b>Fig. 6: Pole Top Mounting Bracket</b> .....	<b>page 15</b>
<b>Fig. 7: Electronic Cabinet Mounting (Side View)</b> .....	<b>page 16</b>
<b>Fig. 8: Siren to Pole Top Mounting Bracket (Side View)</b> .....	<b>page 19</b>
<b>Fig. 9: Antenna Mounting Orientation</b> .....	<b>page 20</b>
<b>Fig. 10: Solar Panel Wiring Connections</b> .....	<b>page 22</b>
<b>Fig. 11: Solar Panel Mounting Views</b> .....	<b>page 23</b>
<b>Fig. 12: Oscillator Board Connections</b> .....	<b>page 25</b>
<b>Fig. 13: AC Outlet Installation</b> .....	<b>page 27</b>
<b>Fig. 14: Battery Connections</b> .....	<b>page 28</b>
<b>Fig. 15: Landline Wiring</b> .....	<b>page 29</b>
<b>Fig. 16: Two-Tone Board</b> .....	<b>page 30</b>
<b>Fig. 17: Aux-In Board</b> .....	<b>page 31</b>
<b>Fig. 18: System LED Diagnostic Indicators</b> .....	<b>page 33</b>
<b>Fig. 19: Siren Cabinet Components</b> .....	<b>page 35</b>
<b>Fig. 20: Station Control Panel</b> .....	<b>page 39</b>
<b>Vortex Wiring Diagram</b> .....	<b>page 58</b>

**Fig. 1: Sample Station Drawing (AC Powered Battery Charger)**



**Fig. 2: Sample Station Drawing (Optional Solar Powered Battery Charger)**



# **CHAPTER 1: INSTALLATION**

## **An Important Note to the Installation Technicians...**

The installation of this product requires careful planning and attention to detail! The installation of this system should NOT be attempted by individuals without experience in the disciplines necessary to this procedure (i.e. High-voltage electrical wiring, utility pole installation, etc.).

**IMPORTANT! Installation of the NEGATIVE battery cable onto the NEGATIVE (-) battery terminal should ALWAYS be the LAST electrical connection made!**

**IMPORTANT! ALWAYS remove the NEGATIVE battery cable from the NEGATIVE (-) battery terminal BEFORE beginning ANY electrical service/repair within the cabinet!**

The installation of the Vortex station provided in this manual follows a logical progression. This process is not arbitrary and was developed using information gathered from both the manufacturer and experienced field technicians. Deviations from any of these procedures are not recommended unless they are in contradiction with local codes. **IN ALL INSTANCES, LOCAL CODES TAKE PRECEDENT OVER PROCEDURES OUTLINED HEREIN.**

It is the responsibility of the installation technicians to read this entire manual. The installation procedure should not begin until all personnel are familiar with the entire process. The overall process includes the following:

### **Installation sequence**

1. Site Selection
2. Utility Pole Preparation
3. Mount Pole Top Bracket and Ground Wire
4. Mount Electronic Cabinet to Pole
5. Mount Siren Assembly to Pole Top Bracket and Conduit to Pole
6. Set Utility Pole
7. Prepare and Mount Antenna Assembly (if present)
8. Prepare and Mount Solar Panels and Conduit (if present)
9. Installation of AC or Solar Service and Batteries
10. Confirm Proper System Operation

## ***Introduction***

*The Vortex™ is an outdoor, public warning siren, ideally suited for firehouse and community warning applications. A standard Vortex™ consists of a rugged speaker array, mounted on a rotor assembly and a self contained electronics control cabinet.*

*The Vortex™ is designed for easy installation and easy operation. The speaker array is factory mounted on to the rotor. The speaker drivers and rotor motor are factory wired, with the cable exiting through a piece of flexible conduit.*

*The electronics cabinet contains all of the control electronics and an isolated battery compartment. This means that there is only one cabinet to install, which simplifies the installation.*

*Operation is further simplified by the presence of LED indicators on all of the key components of the Vortex™. In addition to the status LED's the Vortex™ is equipped Whelen Engineering's patented SI-TEST® as a standard item.*

*Complete details about installation, operation, and service will be covered in this manual. A complete review of the manual is recommended to ensure the best possible siren results.*



## **Section I: Site Selection**

The site selection for the Vortex requires careful consideration in order to achieve the optimum coverage of the siren station. For a guideline to system planning, sound propagation and site selection we direct the user to the Federal Emergency Management Agency's "Outdoor Warning Systems Guide, CPG 1-17."

The Location of the siren site should be reviewed for its compatibility with its surroundings such as private homes, schools and hospitals. The user is cautioned to consider the use of hearing protection devices for service personnel working in close proximity to the speaker cluster.

Access to the siren site is important from the standpoint of service, maintenance inspection and access to a utility service connect.

Site locations for radio controlled units should be reviewed for radio reception.

## **Section II: Utility Pole Preparation...**

### **a) Pole Selection**

**Note: This installation manual will address the procedures applicable to wooden utility poles of specific size and dimensions. Procedures for poles consisting of other materials (steel, concrete, etc.) are not addressed within this document. The information presented, however, provides the necessary data and guidelines for a successful installation regardless of pole material.**

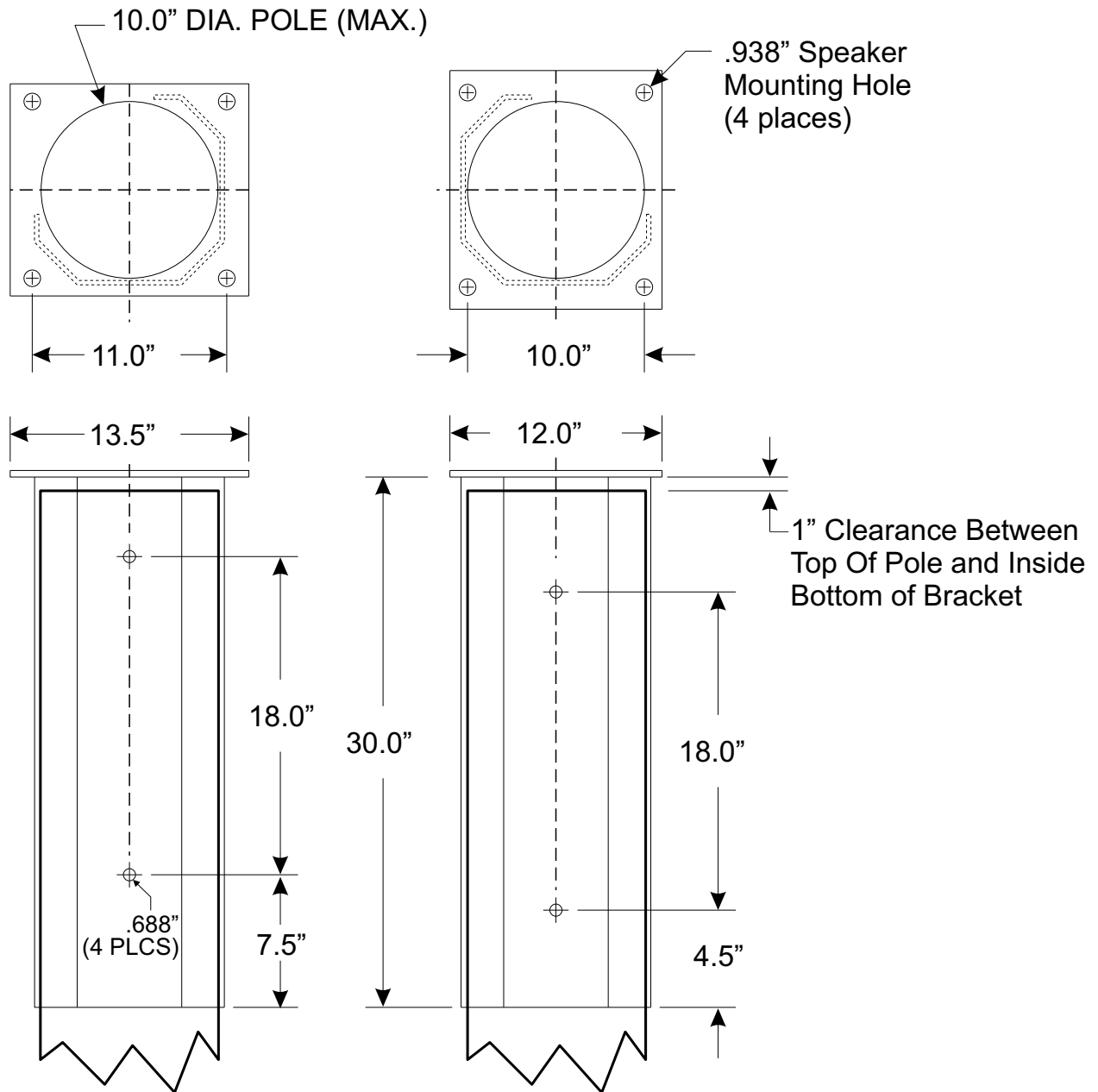
A Vortex system may use a Class 1 or Class 2 utility pole. The total length of the pole referenced within this document is 60 feet. The pole depth of the set pole is 10 feet, leaving a 50 foot pole as measured from the top of the pole to the ground. The utility pole should be set in accordance with local codes.

The inside area of the pole top mounting bracket will accept a pole that is no greater than 10.00” in diameter. On large scale projects, it is beneficial to order the pole to be “gained” to a top diameter of 9.5” +/- .50” for the top 30” section of the utility pole.

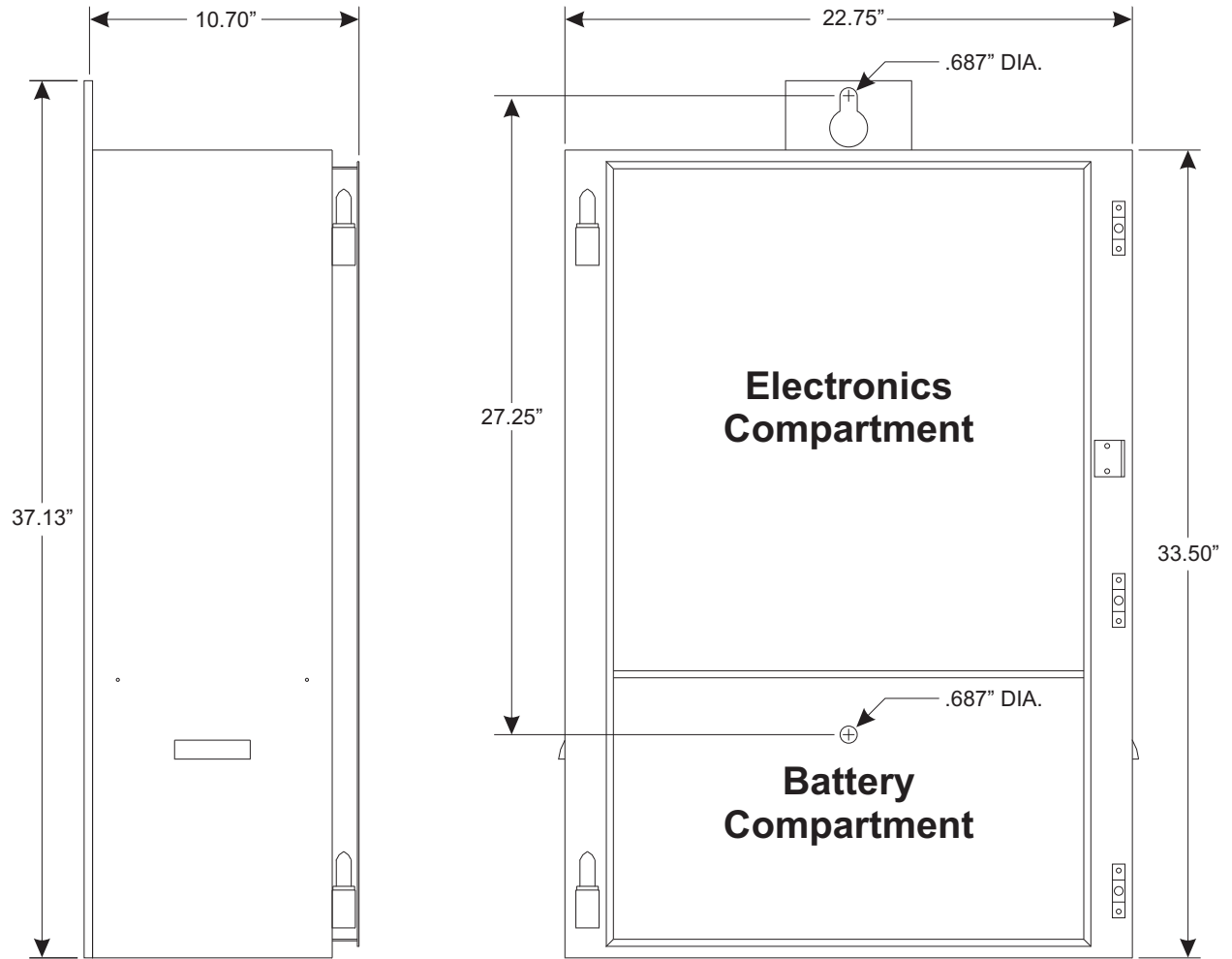
### **b) Component Dimensions**

The utility pole may be pre-drilled prior to installation. The dimensions for all potentially mounted equipment are as follows:

**Fig. 3: Pole Top Mounting Bracket Dimensions**

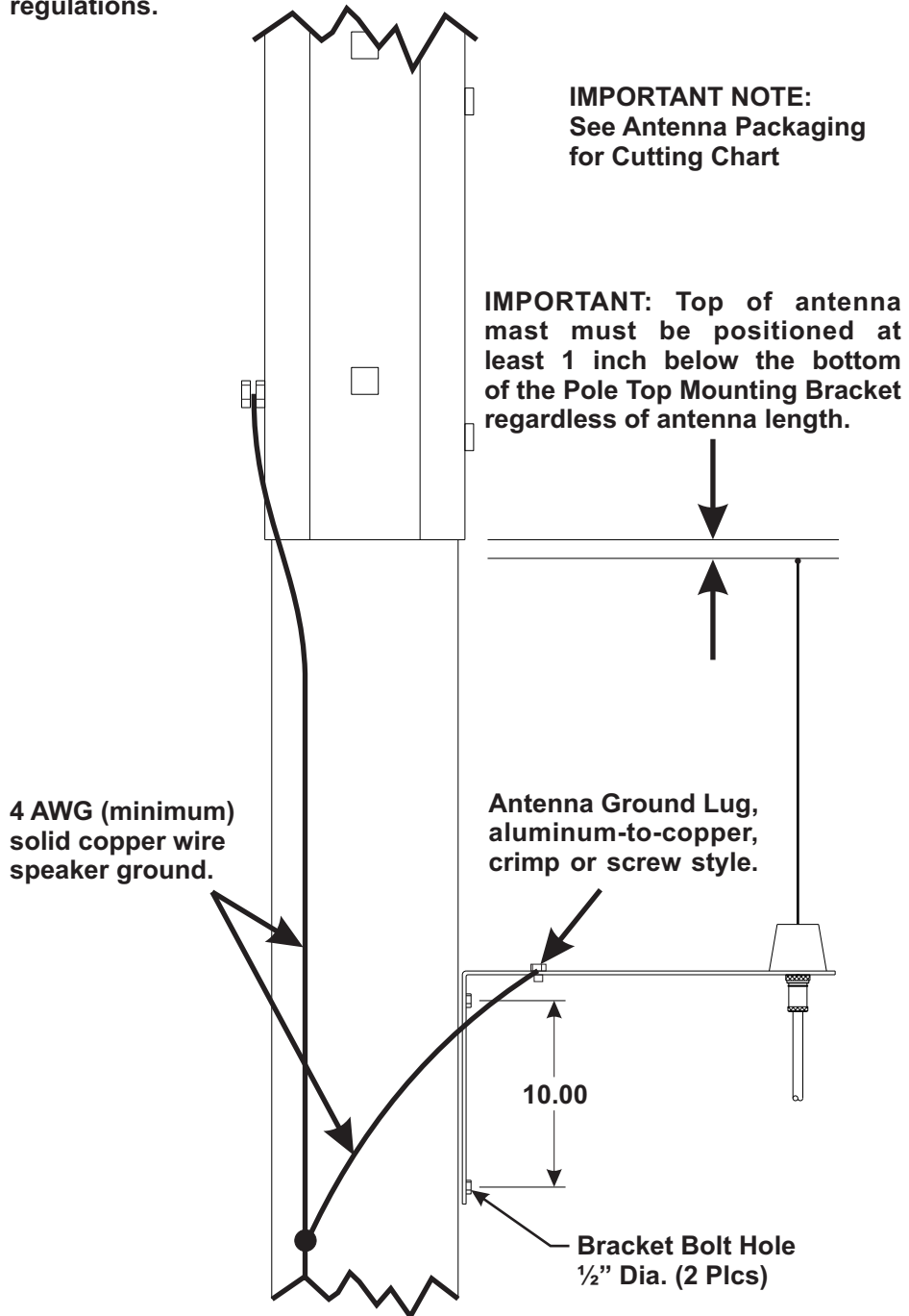


**Fig. 4: Electronic Cabinet Dimensions**



## Fig. 5: Antenna Mounting Bracket Dimensions

**NOTE:** Antenna installation must be in compliance with all FCC regulations.



## **Section III: Equipment Mounting**

### **a) Pole Top Bracket Installation...**

Items required for installation (not included)...

- (4) 5/8" x 14" Hex or Square head mounting bolts**
- (4) 5/8" Hex or Square head nuts**
- (8) 5/8" Flat Washer sized for the above referenced mounting bolt**
- (4) 5/8" Lock Washer**

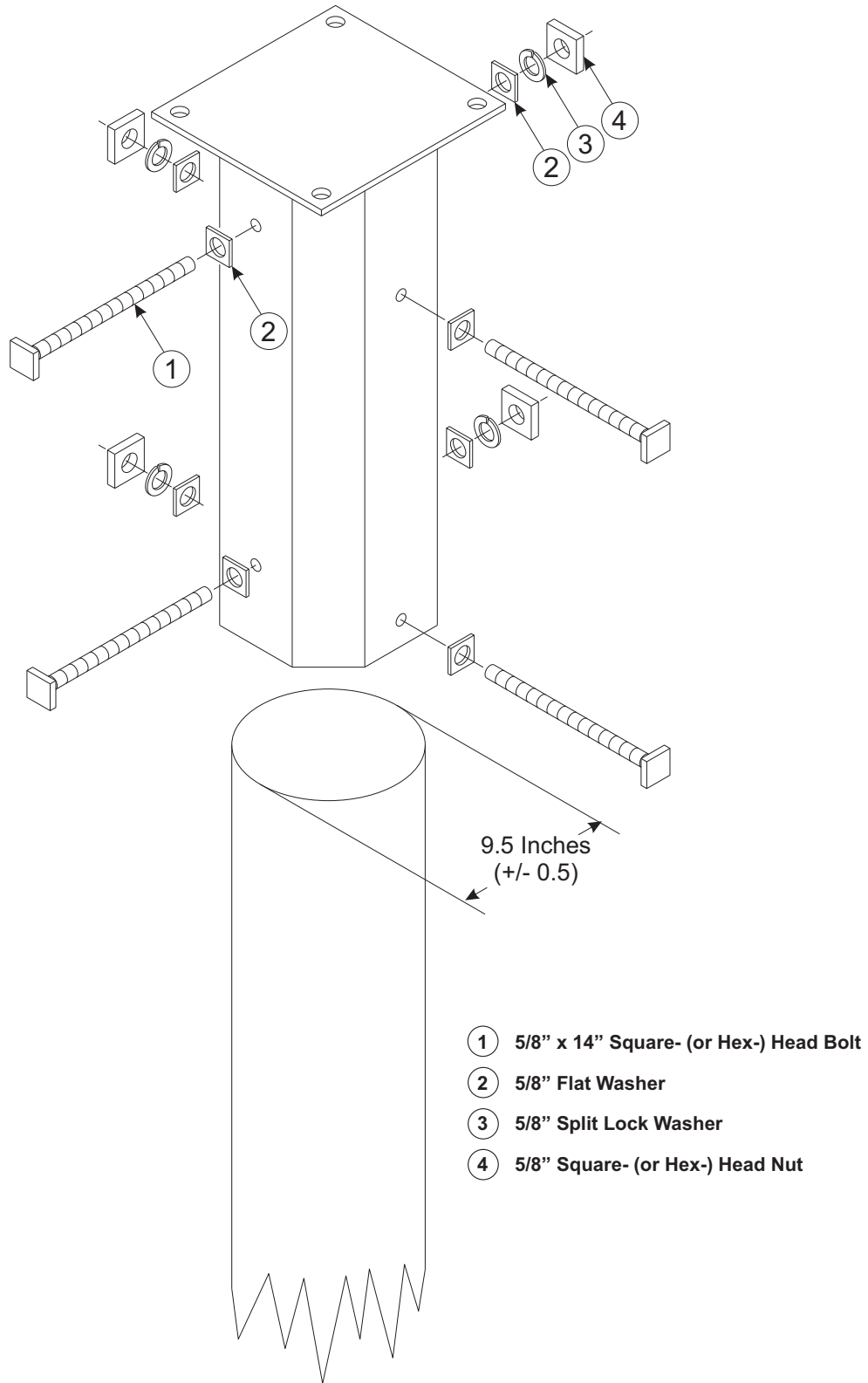
1. Position the Vortex pole top mounting bracket onto the top of the pole (see "Fig. 6: Pole Top Mounting Bracket" on page 15). Make sure there is a 1 inch space between the top of the pole and the pole top mounting bracket (see "Fig. 7: Electronic Cabinet Mounting (Side View)" on page 16).

**Note:**        **The inside area of the pole top mounting bracket will accept a pole that is no greater than 10.00" in diameter. On large scale projects, it is beneficial to order the pole to be "gained" to a top diameter of 9.5" +/- .50" for the top 30" section of the utility pole.**

2. Using the pole top mounting bracket as a guide, drill four mounting holes through the pole at the bracket mounting hole locations. These holes should be sized to accommodate the above referenced hardware.
3. Secure the bracket to the pole using the prescribed hardware (see "Fig. 6: Pole Top Mounting Bracket" on page 15). Be sure to position all the associated hardware items in their proper order.
4. Secure a length of #4 solid copper wire to the pole top bracket grounding lug using the supplied nut. Make sure that this wire is of sufficient length to reach the ground when the pole has been set.

**Note:**        **All Hardware used for connecting equipment to the utility pole should be inspected for tightness between 12 to 18 months after installation. Some shrinkage of the newly treated utility pole may occur, loosening connections.**

**Fig. 6: Pole Top Mounting Bracket**

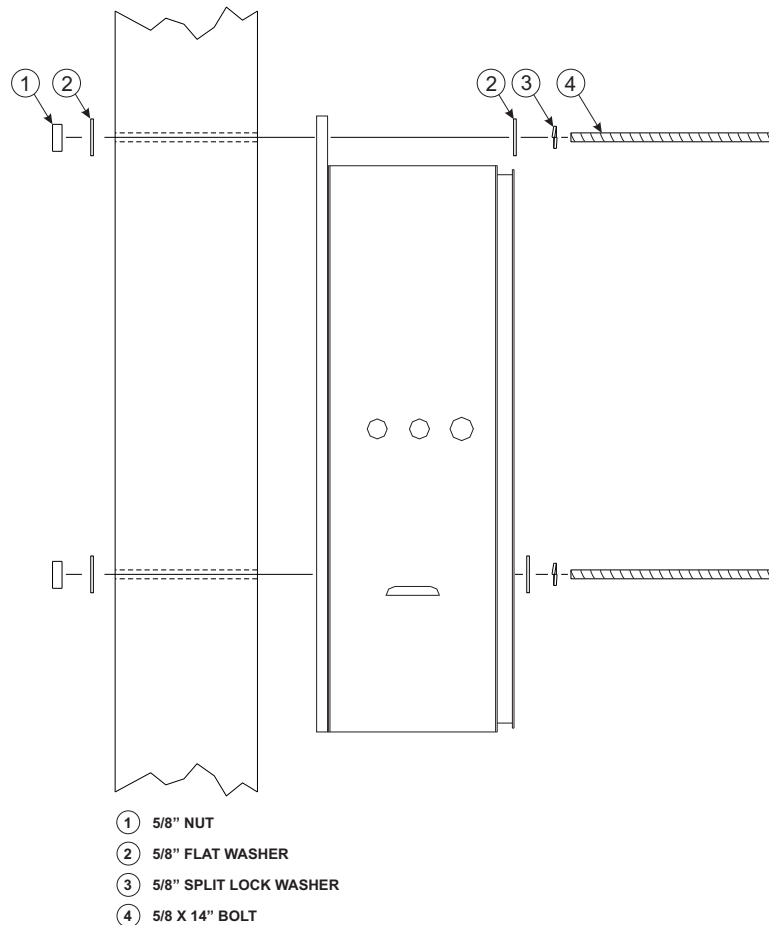


## b) Electronic Cabinet Mounting...

Items Required for installation (not included)....

<u>Qty.</u>	<u>Description</u>
(2)	5/8" x 14" Hex or Square head mounting bolts
(4)	5/8" Flat Washer sized for the above mounting bolt
(2)	5/8" Split-Lock Washer
(2)	5/8" Hex or Square head nuts
(1)	Aluminum-to-Copper lug sized for #4 ground wire (crimp or screw style)
(1)	Stainless Steel 1/4-20 x 2" bolt with appropriately sized flat washer, split-lock washer and nut
(1)	10' Copper ground rod

**Fig. 7: Electronic Cabinet Mounting (Side View)**





The Vortex siren case assembly may be installed onto the pole and wired before setting the pole.

1. It is necessary for the installer to remember that two factors should determine the optimum mounting location; the desired distance of the mounted cabinet to the ground (typically 10 to 12 feet as measured from the bottom of the cabinet) and available speaker wire length (speaker assemblies are provided with a minimum of 50 feet of speaker wire as measured from the bottom of the speaker assembly).
2. After the mounting location has been determined, drill an appropriately sized thru-hole into the pole at the top cabinet mounting hole. Install a bolt loosely into the hole and hang the cabinet onto the bolt.
3. With the cabinet fitted snugly to the pole, mark the surface of the pole at the lower mounting hole location inside the battery storage compartment. Remove the cabinet from the pole and drill an appropriately sized thru-hole into the pole at the location(s) marked. Return the cabinet to its mounting location and secure to the pole using the specified hardware.
4. Install an aluminum-to-copper lug (crimp or screw style) onto the #4 solid copper wire. Secure this to the cabinet mounting channel in hole supplied using stainless steel 1/4-20 hardware.
5. Install the ground rod as specified by local codes and connect both copper wires (from pole top mounting bracket and electronic cabinet) to this rod.
6. Install rigid steel conduit and necessary couplings from the speaker's 1" conduit adapter to the 1" speaker conduit protruding from the base of the siren case assembly. The first section of conduit may be installed onto the speaker's base casting prior to mounting the speaker to the pole top bracket. At the option of the user, conduit unions may be used between the first section of conduit and the speaker base casting and at the speaker cable conduit entrance to the siren case assembly.

**Note: If the location of the conduit on the pole requires difficult conduit bends or couplings, a section of metal bonded seal tight conduit NOT TO EXCEED 24 INCHES may be used at the top of the pole and/or at the bottom of the pole as needed for the speaker cable installation.**

Batteries for the system should not be installed until the siren station is set in place, otherwise some leakage of the battery fluid may occur. Batteries should not be connected to the system until AC power (or solar power if equipped) is available to the system to operate the system's battery charger.

### **c) Siren Assembly Mounting**

Hardware required for installation (factory included)....

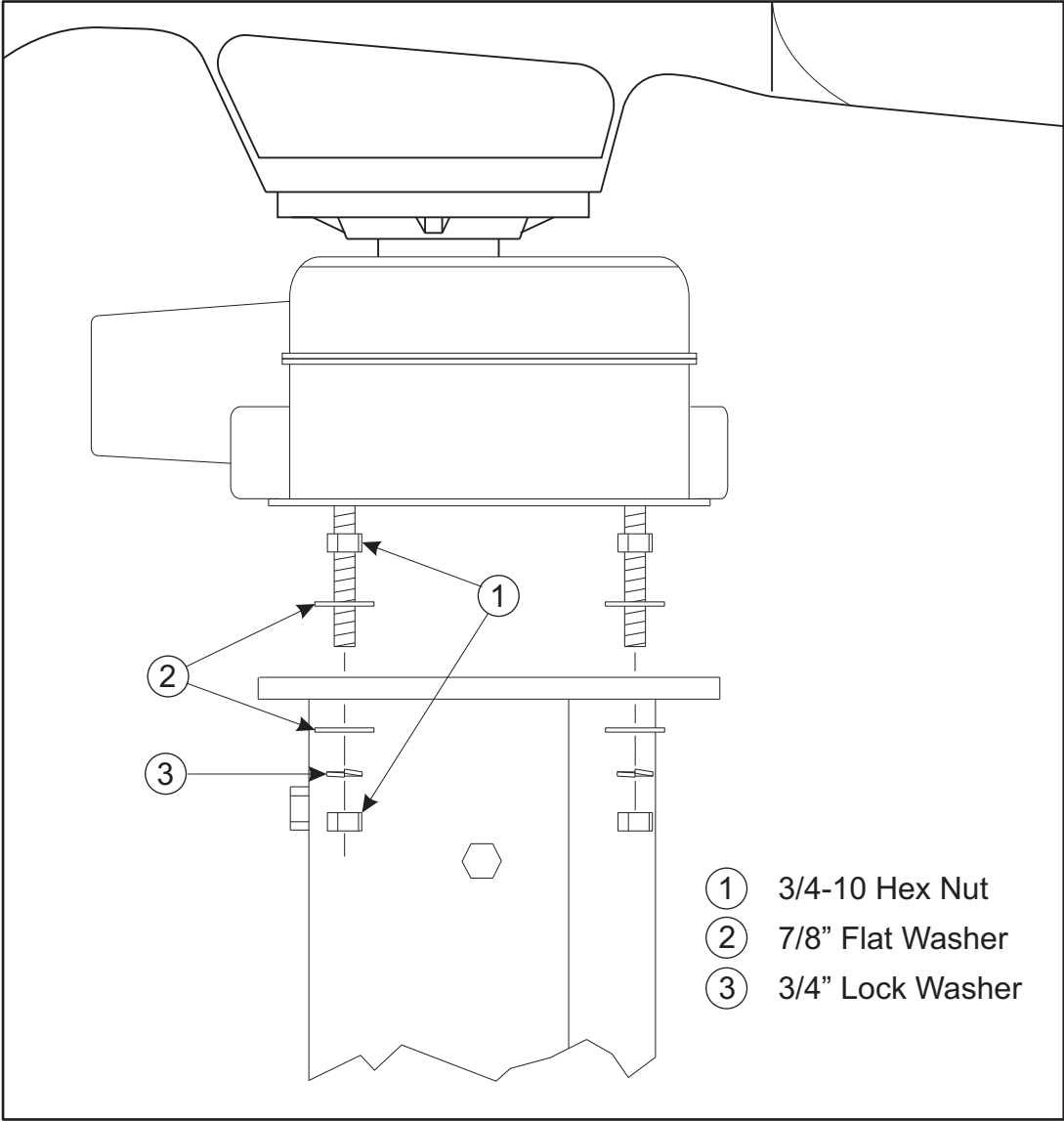
- (8) 3/4"-10 hex head nuts**
- (8) 7/8" Flat Washers**
- (4) 3/4" Split Lock Washers**

1. Sling or cradle the utility pole in a safe manner so that the pole top is 3 to 4 feet off the ground. This will allow the speaker assembly to clear the ground when installed.
2. Locate the 4 mounting studs on the bottom of the speaker assembly (see "Fig. 8: Siren to Pole Top Mounting Bracket (Side View)" on page 19).
3. Thread a 3/4" hex nut onto each of the mounting studs until there is approximately 1" of space between the top of the nuts and the bottom of the siren assembly. This space will allow the speaker assembly to be leveled once the pole has been set.
4. Install a 7/8" flat washer onto each of the mounting studs.
5. Insert the four mounting studs through the mounting holes on the top of the pole top bracket. The bottom of the siren assembly should lie flat against the pole top bracket.
6. Install a 7/8" flat washer onto each of the mounting studs.
7. Install a 3/4" split lock-washer onto each of the mounting studs.
8. Thread a 3/4" hex nut onto each of the mounting studs. Tighten this nut firmly to secure the siren assembly to the pole top bracket.

At this point the pole should now be set. However, the installer may use their own discretion as to whether to mount the electronic cabinet onto the utility pole before the pole is set.

When the pole has been set, use the adjustment nuts (indicated in step 3) to adjust the siren assembly until it is level.

**Fig. 8: Siren to Pole Top Mounting Bracket (Side View)**



#### d) Antenna Mounting (optional)...

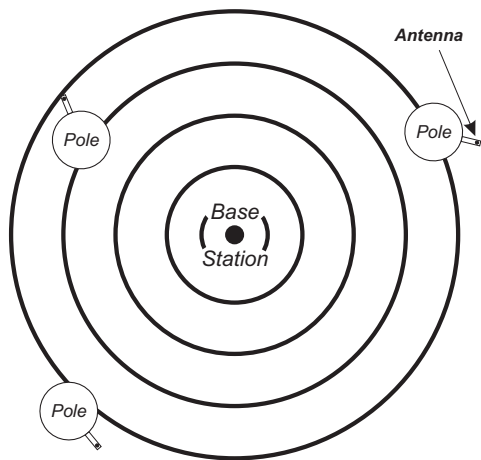
**Note:**        **Antenna installation must be in compliance with all FCC regulations.**

The proper antenna bracket mounting location is determined by several considerations. The antenna bracket should be positioned as high on the utility pole as is possible. However, under no circumstances should the top of the installed antenna must be any closer than one inch from the bottom of the Pole Top Mounting Bracket (see “Fig. 6: Pole Top Mounting Bracket” on page 15). Be sure to ground the antenna bracket as shown using 4 AWG solid copper wire. The antenna cable provided by the factory is 35 feet in length.

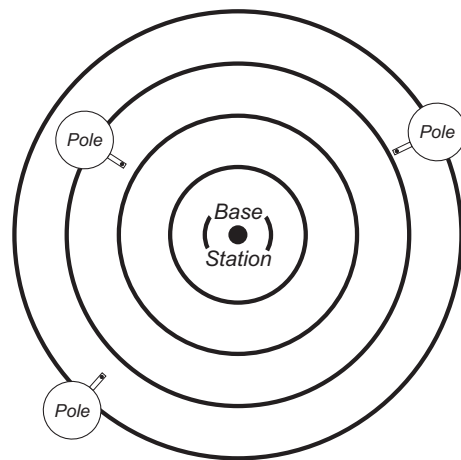
It is also important to remember that the antenna **MUST** be mounted on the side of the utility pole that faces the transmitter (see below)

**Fig. 9: Antenna Mounting Orientation**

#### *Improper Antenna Orientation*



#### *Correct Antenna Orientation*



Refer to the installation sheet included with your antenna kit for further information regarding cable connections and antenna trimming.

### **e) Solar Panel Mounting (optional)...**

The solar panel must be installed so that it is directly facing the earth's equator with an unobstructed view. Failure to orient the solar panel in this way will result in significantly reduced charging effectiveness.

The most critical aspect of properly mounting the solar panel involves achieving the optimum tilt angle. The tilt angle is determined by the distance between the upper and lower mounting brackets, as shown.

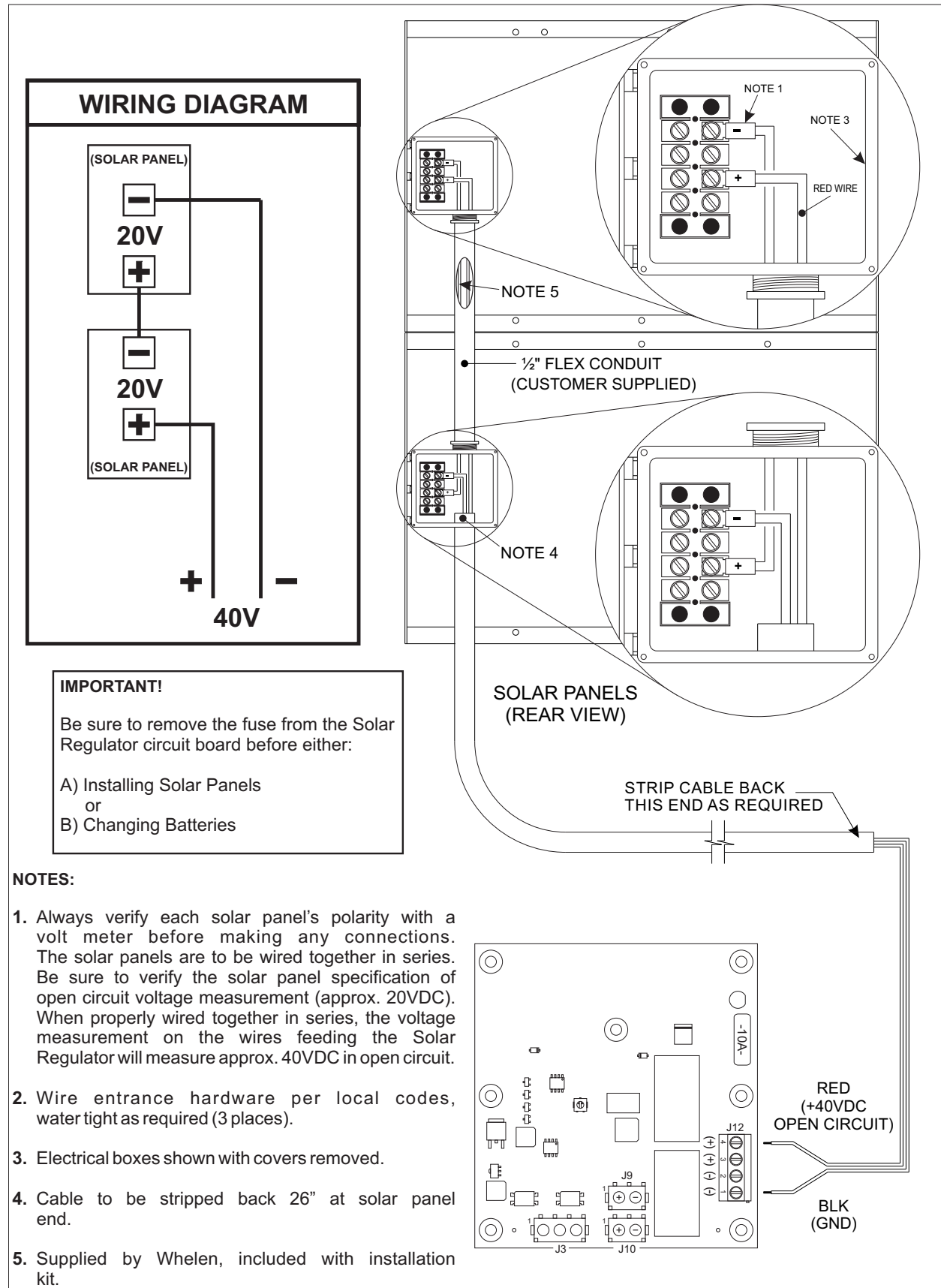
Refer to page 22 for electrical connection information.

Refer to page 23 for general solar panel mounting.

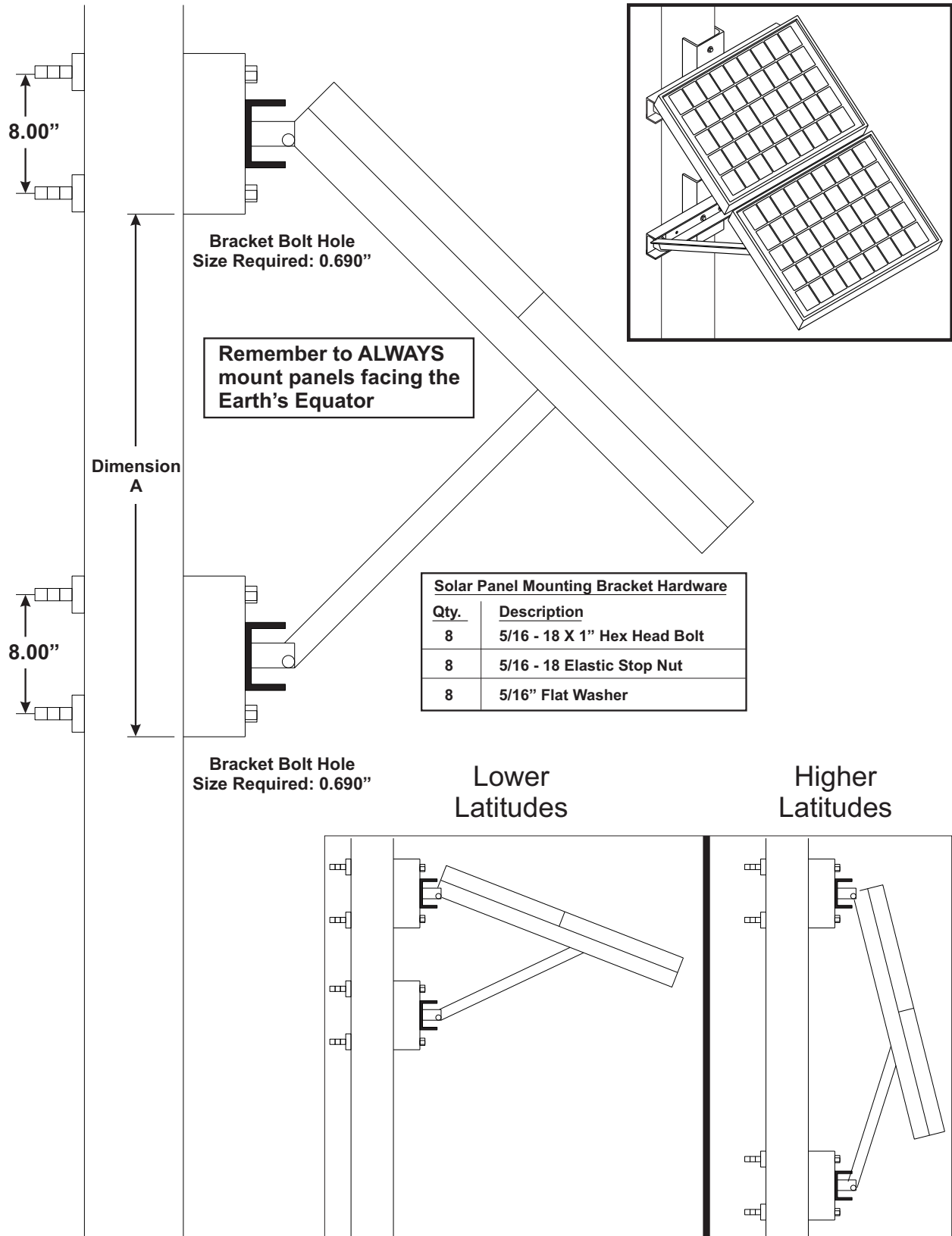
Refer to page 24 for information on determining your specific mounting angle.

Run rigid steel conduit from the solar panel to the 3/4" AC knockout located at the bottom of the siren case assembly. A section of up to 24 inches of metal bonded seal tight conduit may be utilized where conduit connections to the solar panel or electronic cabinet are not conveniently accomplished with rigid steel conduit and fittings. This conduit should be sealed to prevent insects and pests from entering the siren case assembly.

**Fig. 10: Solar Panel Wiring Connections**



**Fig. 11: Solar Panel Mounting Views**



## f) Determining Solar Panel Mounting Angle

1. Determine the *LATITUDE* of your location.
2. Find your *Latitude* on the table below and note the corresponding *Tilt Angle*.

### LATITUDE

**0° to 9°**

**10° to 20°**

**21° to 45°**

**46° to 65°**

**66° to 75°**

### TILT ANGLE

**75° = Tilt Angle**

**85° minus LATITUDE = Tilt Angle**

**80° minus LATITUDE = Tilt Angle**

**75° minus LATITUDE = Tilt Angle**

**10° minus LATITUDE = Tilt Angle**

3. Locate your TILT ANGLE in the list below. For every TILT ANGLE, there is a corresponding “Dimension A”. “Dimension A” represents the distance from the bottom of the upper mounting bracket to the bottom of the lower mounting bracket.

#### example 1:

**Location LATITUDE is 30°**

**80° - 30° = 50° Tilt Angle**

**50° Tilt Angle = 33.60” Dimension A**

#### example 2:

**Location LATITUDE is 7°**

**7° = 75° Tilt Angle**

**75° Tilt Angle = 15.54” Dimension A**

Tilt Angle	Dimension A (inches)
10	50.49
11	50.34
12	50.16
13	49.97
14	49.77
15	49.55
16	49.32
17	49.08
18	48.82
19	48.54
20	48.25
21	47.95
22	47.63
23	47.30
24	46.95
25	46.59
26	46.22
27	45.83
28	45.43
29	45.02
30	44.60
31	44.16

Tilt Angle	Dimension A (inches)
32	43.71
33	43.24
34	42.77
35	42.28
36	41.78
37	41.26
38	40.74
39	40.20
40	39.65
41	39.10
42	38.53
43	37.95
44	37.36
45	36.75
46	36.14
47	35.52
48	34.89
49	34.25
50	33.60
51	32.95
52	32.28
53	31.61

Tilt Angle	Dimension A (inches)
54	30.93
55	30.24
56	29.54
57	28.84
58	28.13
59	27.41
60	26.69
61	25.96
62	25.23
63	24.50
64	23.76
65	23.01
66	22.27
67	21.52
68	20.77
69	20.02
70	19.27
71	18.52
72	17.77
73	17.02
74	16.28
75	15.54



## Section IV: Wiring

This section covers field wiring for the Speaker/Rotor Assembly and the AC service.

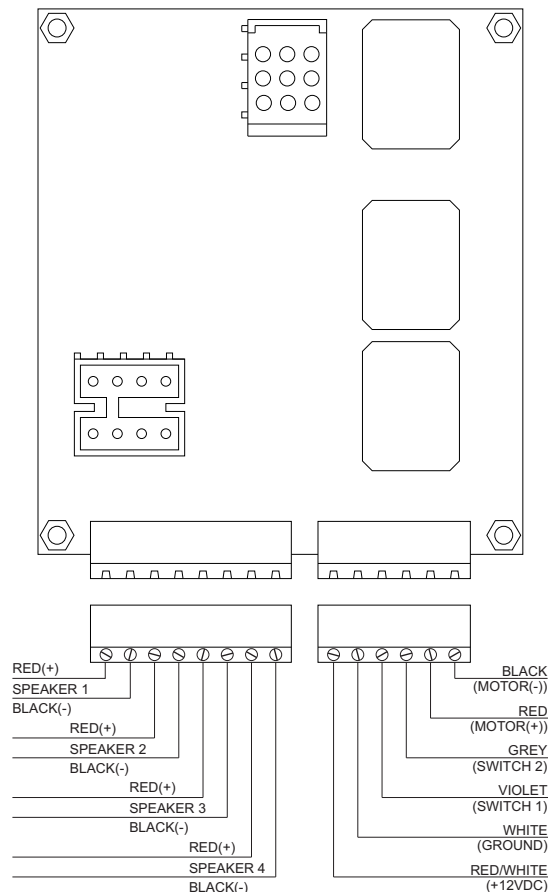
### a) Speaker/Rotor Wiring

The 14 conductor Speaker/Rotor cable has five red wires, five black wires, one gray, one violet, one white and a red wire with a white strip. Each of the red and black wires has a white ink identifier on it. The wires are grouped in red and black pairs, with labels 1, 2, 3, 4 and M. **The red and black wires are polarity sensitive.** Pair 1 is wired to speaker driver 1, which is the bottom driver of the speaker, pair 2 is wired to speaker driver 2, which is the next driver up the speaker and so on. Pair M is connected to the rotor motor. The other four wires are connected to limit switches in the rotor.

The speaker driver wires (red & black 1-4) connect to the 8-position Phoenix connector on the oscillator board. The rotor wires connect to the 6-position Phoenix connector. This board is mounted to the inner, left, vertical wall of the upper cabinet compartment. Refer to Fig. 12 for the specific designations and destinations for both the speaker and rotor wires.

**NOTE: Speaker pair #5 is extra and is not used in this installation.**

**Fig. 12: Oscillator Board Connections**



## b) AC Wiring

An AC Service (Single Phase only) with an acceptable disconnect is required. A 15 amp (minimum) 120 VAC circuit is recommended.

Locate the service on the pole according to local codes, taking care that the service entrance will meet height requirements once the pole is set into place.

The Vortex includes a 15 amp, 120 VAC outlet and a 2" x 4" electrical box. The cabinet's battery charger plugs into one of the receptacles. The remaining receptacle is available for use by service personnel (see "Fig. 13: AC Outlet Installation" on page 27).

**Note:**        **A section of up to 24 inches of metal bonded seal tight conduit may be utilized where conduit connections to the siren case assembly are not conveniently accomplished with rigid steel conduit and fittings.**

Each Vortex siren system is supplied with a Lightning arrestor which is to be installed on the load side of the AC service. Local codes should be reviewed and followed to establish the connection of this device on the primary or secondary side of the disconnect.

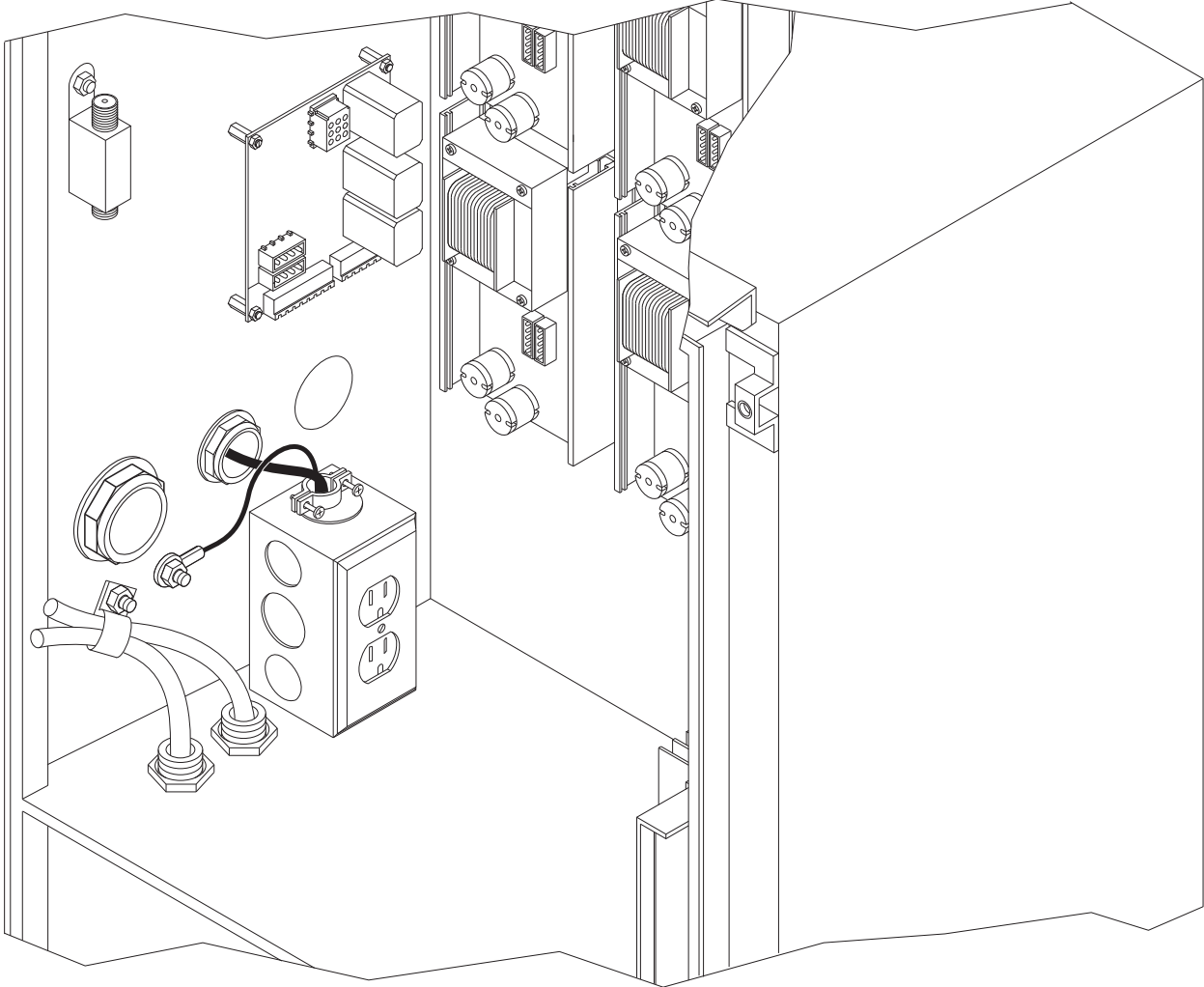
**Note:**        **The location of the siren site should be reviewed for the quality of the AC service. AC power sources that are subject to excessive power surges or transients are not acceptable.**

Make sure the battery charger is unplugged from the AC outlet in the left rear corner of the control cabinet. Route the AC service wire through the cable clamp on top of the box. Make the AC connections to the outlet, according to local electrical codes.

Locate the green wire in the outlet box. This is the cabinet chassis ground. Connect the green wire to the ground wire of the electrical service, within the outlet box. Make a ground connection from one of the lower mounting tabs to earth ground using minimum of 4 AWG copper wire. An Aluminum-to-Copper (ALCO) connector must be used for ground connection to the cabinet. Always follow local codes.

Leave the battery charger unplugged.

**Fig. 13: AC Outlet Installation**



### c) Batteries

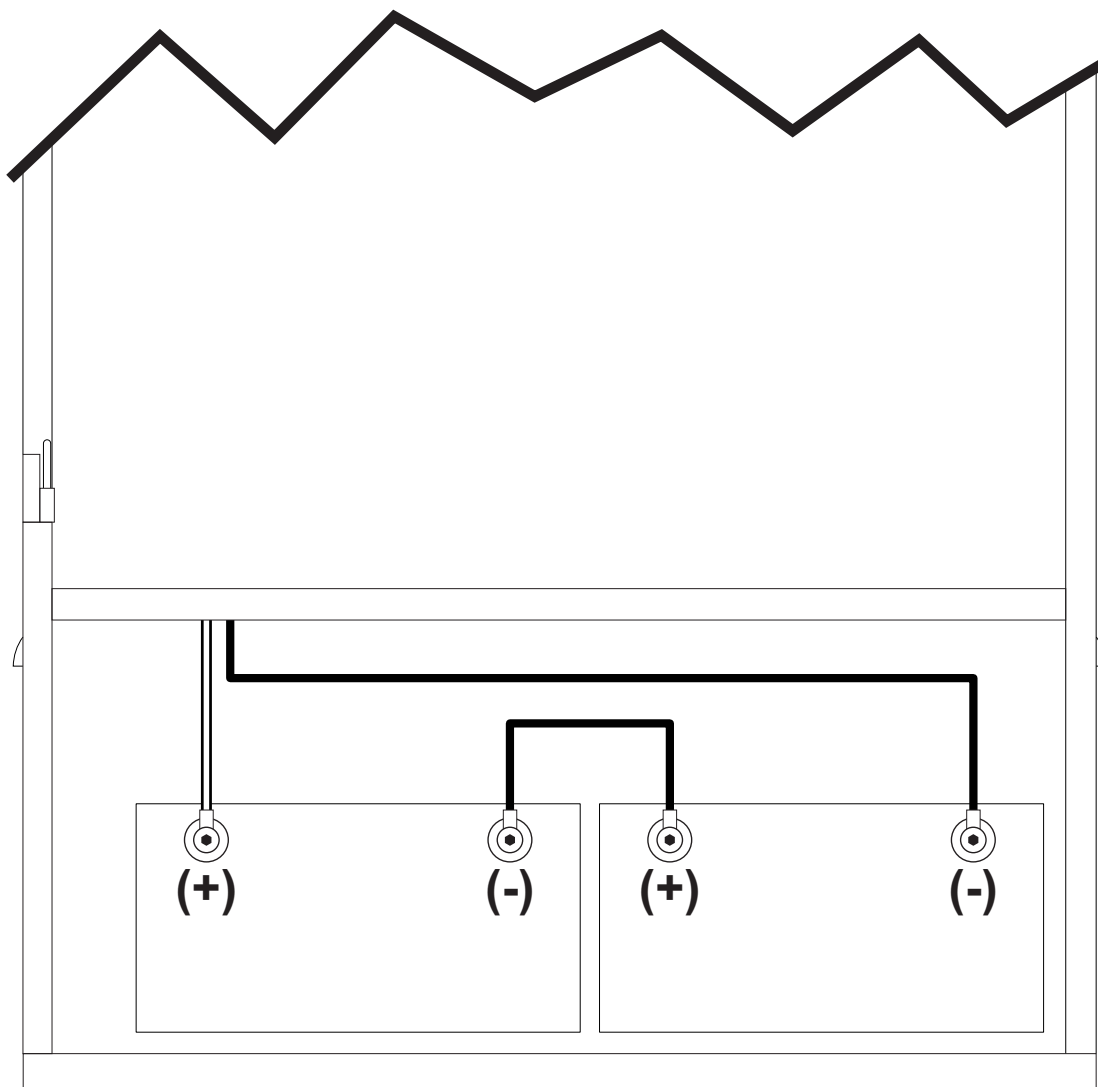
1. Install the batteries and connect them as shown in the illustration below. **MAKE SURE TO OBSERVE THE POLARITY OF THE TERMINALS BEFORE MAKING ANY CONNECTIONS.**

**Note:** For battery wiring, DC wiring conventions are used (**BLACK** is ground (-)).

**IMPORTANT!** Installation of the **NEGATIVE** battery cable onto the **NEGATIVE (-)** battery terminal should **ALWAYS** be the **LAST** electrical connection made!

2. Plug the battery charger into the AC outlet.
3. Verify system operation as outlined in the system maintenance check list.

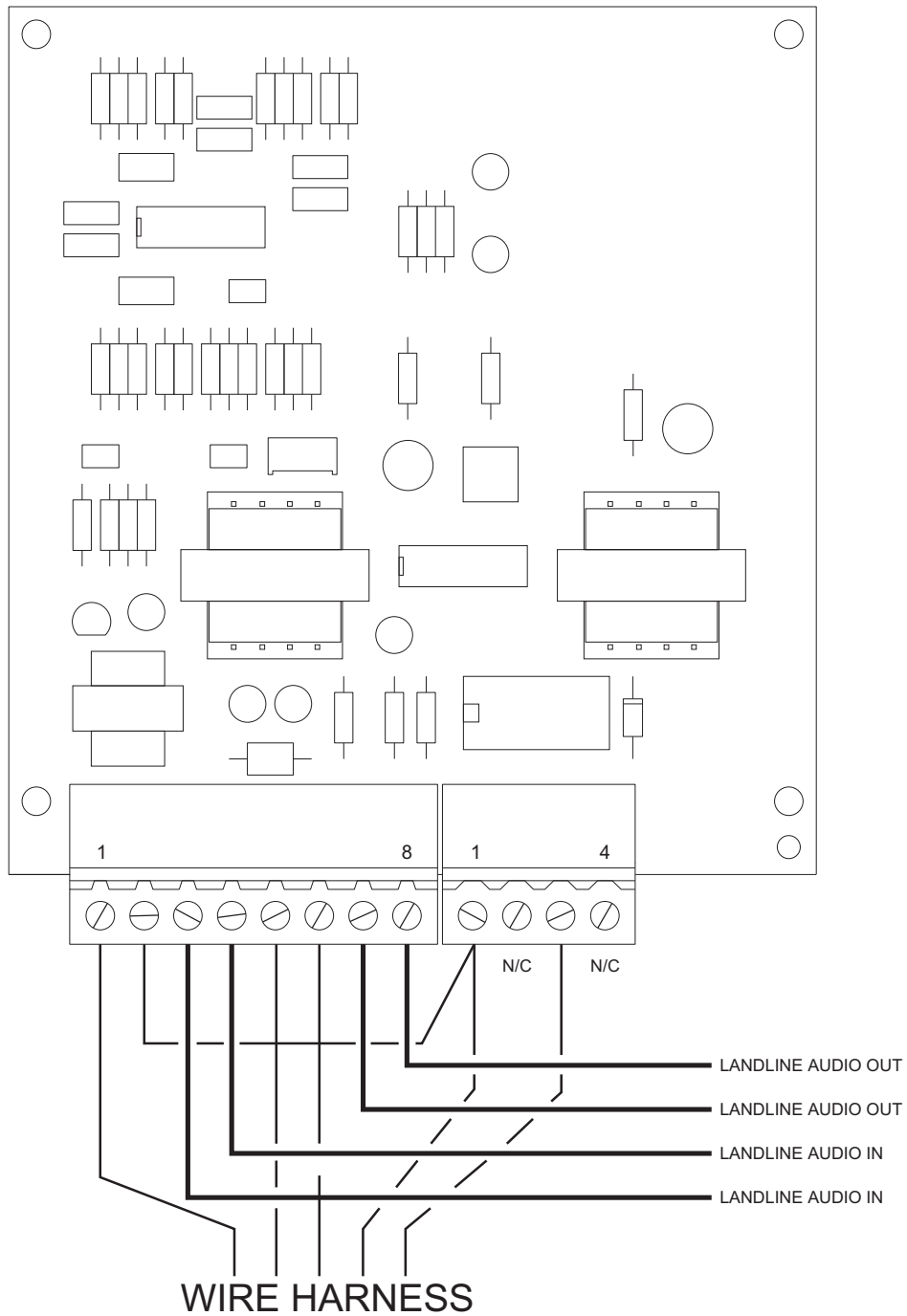
**Fig. 14: Battery Connections**



### d) Landline (optional)

As an option, the Vortex may be remotely controlled by either landline or RF link. Either method communicates via a DTMF protocol. Remote control may be one-way or two-way. The one-way option simply controls the Vortex, while the two-way option controls the Vortex and reports Vortex status back to a central control point.

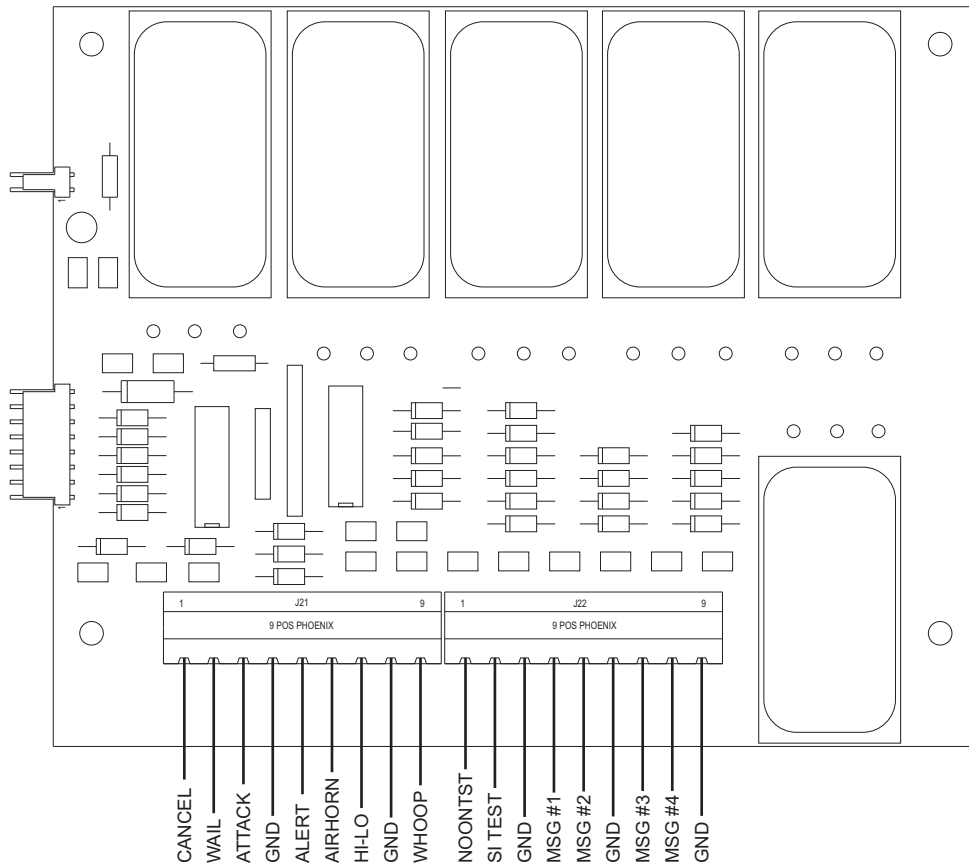
**Fig. 15: Landline Wiring**



### e) Two-Tone (optional)

The Two Tone Decoder may be equipped with up to six decode modules. The modules can be programmed with two-tone pairs between the frequencies of 400Hz to 2KHz. The appropriate decode module is factory wired to the appropriate Vortex command, provided the information is supplied to the factory.

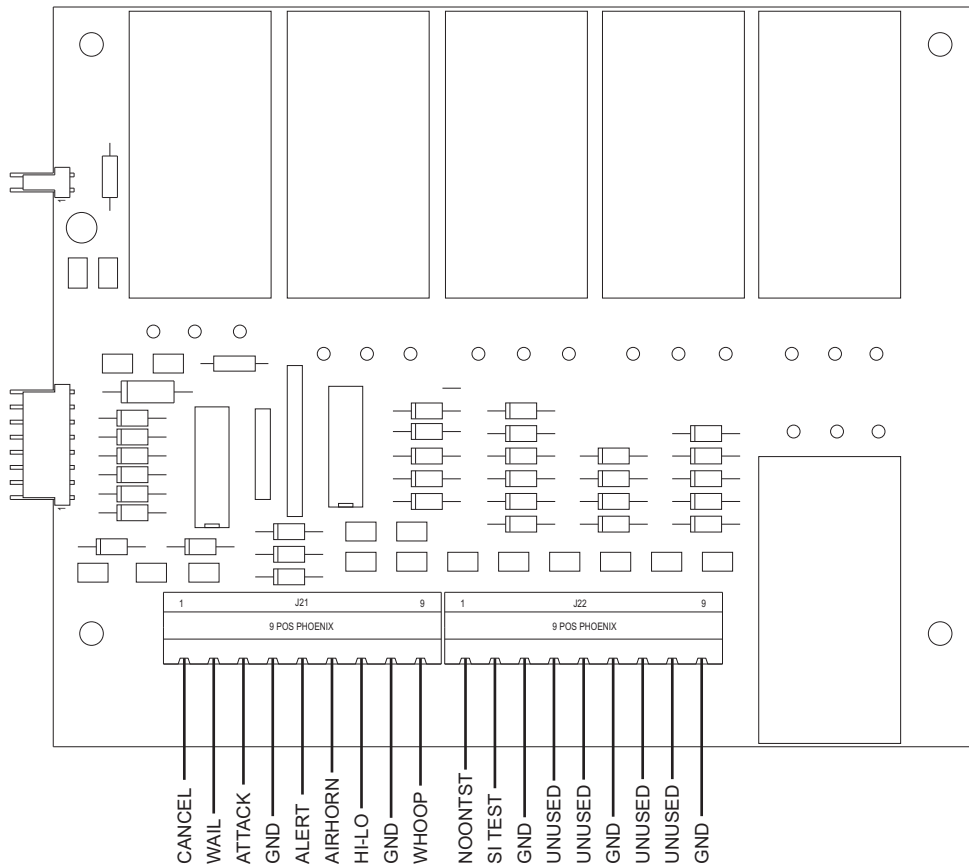
**Fig. 16: Two-Tone Board**



### f) Aux-In (optional)

Vortex siren functions can be activated via external auxiliary input contact closure. For external controls, the “closure” must be at least 1/2 a second in duration. The “closure” must be made to ground. A ground contact is supplied at the terminal strip for this reason.

**Fig. 17: Aux-In Board**



## **Section V: System Test...**

After the installation of the Vortex station has been completed, a basic system check is recommended to confirm that the system is functioning properly. Before initiating these tests, locate the system LED's on the control board mounted to the cabinet door (see "Fig. 18: System LED Diagnostic Indicators" on page 33).

1. Confirm that the ACTIVE light on the control board is flashing at a rate of a 1/2 second on and a 1/2 second off.
2. Press the SI TEST® button on the siren front panel and check to make sure that all the siren amplifier diagnostic LED's illuminate for 5 seconds. These LED's are located on each amplifiers circuit board.
3. Confirm that the speaker has turned one complete rotation.
4. After the amplifier LED's turn off, check to see if the AC, DC, PARTIAL, FULL and ROTOR LED's are on.

If one of your amplifier lights did not illuminate during this test then refer to the procedure below to troubleshoot the problem.

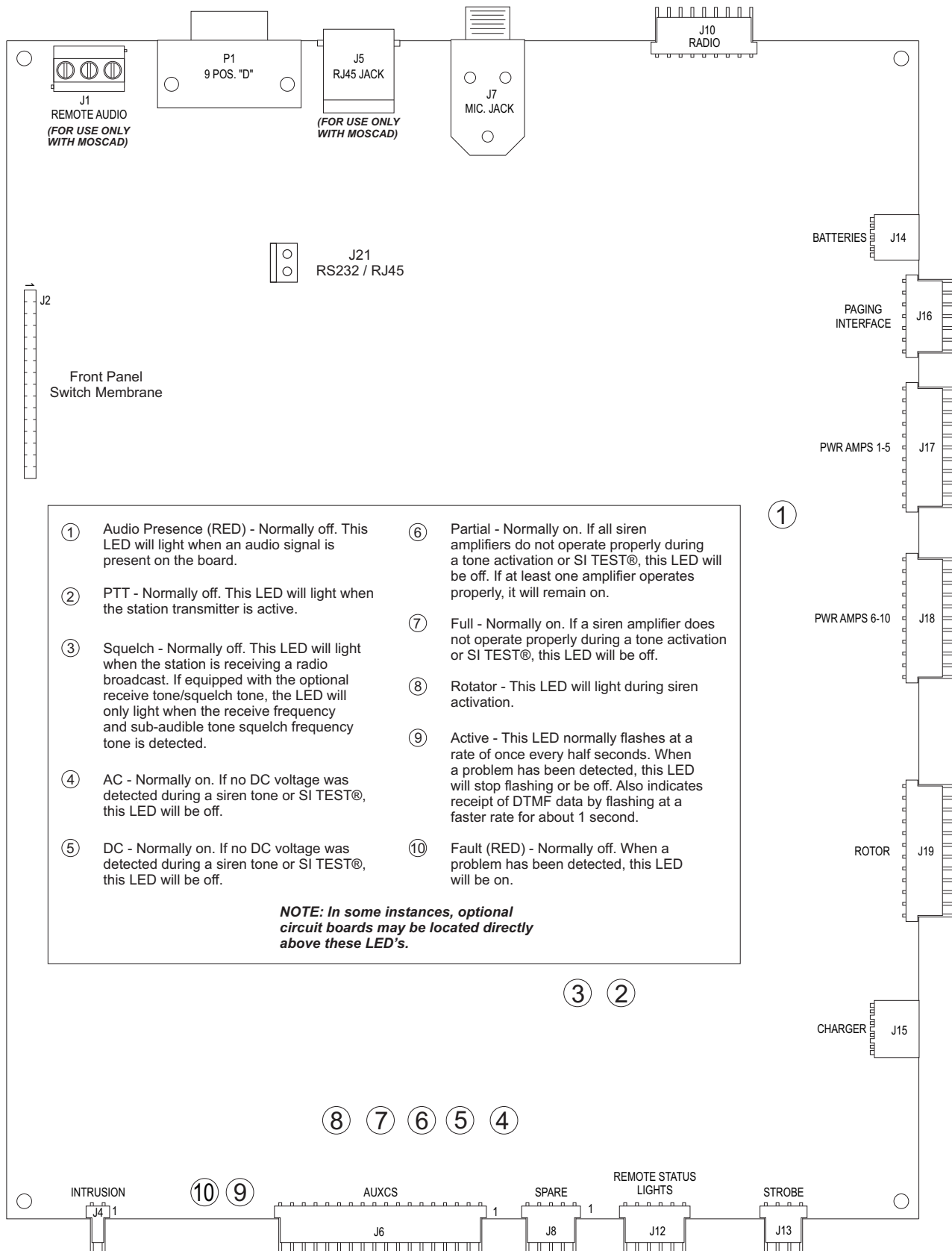
This procedure may be used when the Partial or Full LED's indicate a failure.

**Note:**            **In order for a "Full" indication to be valid, the "Partial" LED must also be on.**

1. Press the SI TEST® button located on the front panel of the electronic cabinet. Each amplifier has a red LED on its circuit board.
2. A SI TEST® will cause each amplifier's diagnostic indicator to turn on. If one or more do not turn on, proceed to step 3. If all indicators turn on, the siren amplifiers are functioning properly.
3. Open the front panel and remove the speaker driver from the amplifier that did not light and install it onto an amplifier that did light. For example: If amplifier 1 did not light but amplifier 2 did, install speaker 1 on amplifier 2 and speaker 2 on amplifier 1. This will indicate if the failure was with the speaker or the amplifier.



**Fig. 18: System LED Diagnostic Indicators**



# **CHAPTER 2: OPERATION**

# Section VI: Overview of System Components

## a) Station Component Locations

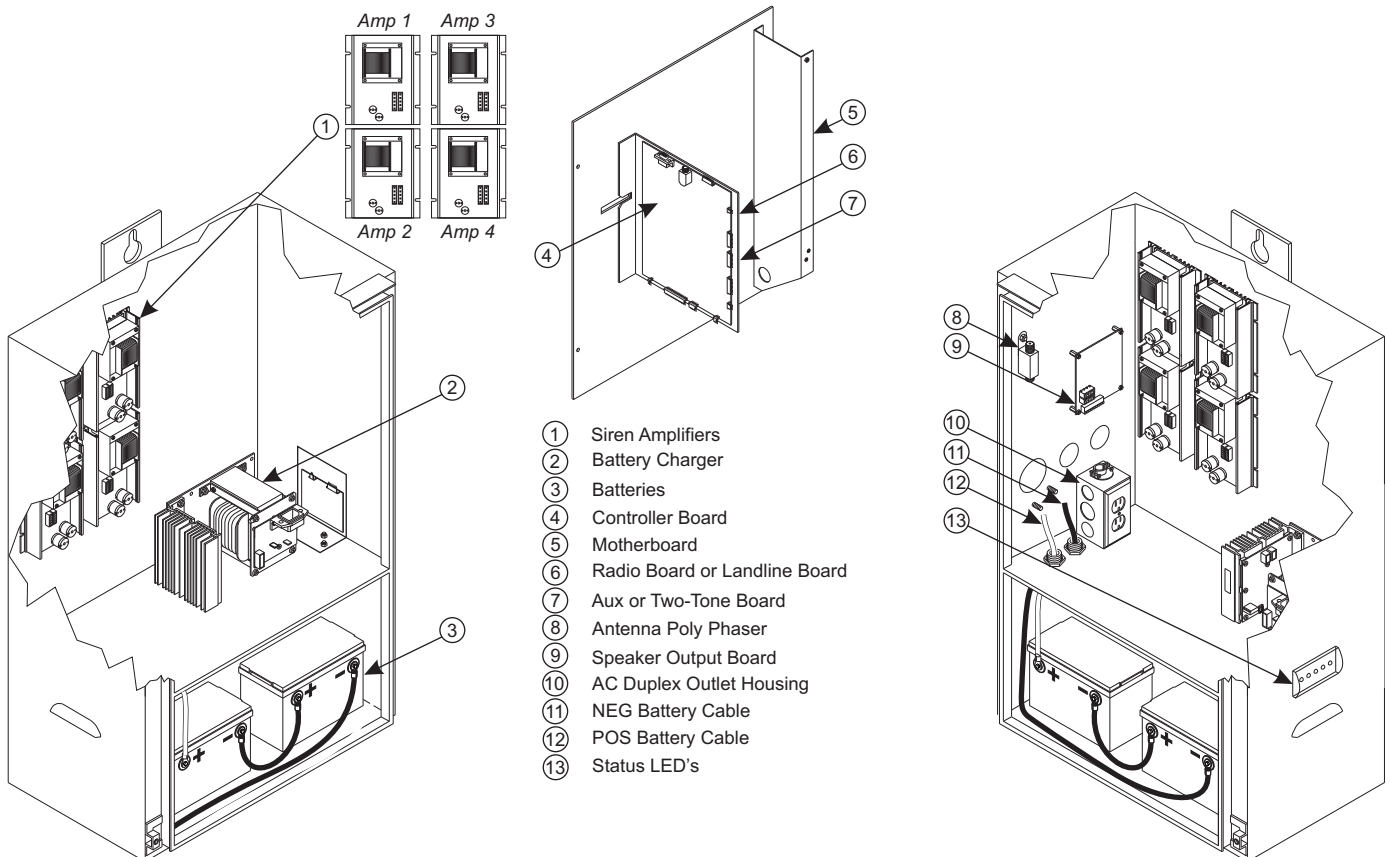
The Vortex System is comprised of four basic models:

<u>Model</u>	<u>Driver Info</u>
<b>VORTEXR1</b>	<b>One Siren Driver</b>
<b>VORTEXR2</b>	<b>Two Siren Drivers</b>
<b>VORTEXR3</b>	<b>Three siren drivers</b>
<b>VORTEXR4</b>	<b>Four siren drivers</b>

Both systems essentially function in the same manner. This manual will provide the necessary information to properly operate, program and diagnose this system regardless of specific model.

The Vortex systems is comprised of several major components common to both models, although quantities of some components will vary from model to model.

**Fig. 19: Siren Cabinet Components**



## b) Station Components Defined

*Siren Amplifier* - These components (located on the rear wall of the upper cabinet compartment) receive the desired tone generated by the control board, amplify it and deliver it to the siren driver. Vortex3 systems use 3 amplifiers; Vortex4 systems use 4. **NOTE: At no time should the siren be activated when the speaker is not connected!**

*Aux-in Board (Optional)* - This component (located on the inside of the upper cabinet door) can be wired to provide remote activation of all siren functions *via* momentary contact closure.

*Two-Tone Board (Optional)* - This component (located on the inside of the upper cabinet door) receives two-tone signals from either the antenna or landline and delivers them to the control board for processing.

*AC Battery Charger* - This component (located on the rear wall of the upper cabinet compartment) uses 110 VAC (or 220 VAC) single-phase service to maintain the station batteries at their proper voltages.

*Solar Regulator (optional)* - This component (located on the rear wall of the upper cabinet compartment) uses electrical energy collected by a pole-mounted solar panel to maintain the station batteries at their proper voltages.

*Batteries* - These components (located on the inside of the lower cabinet) provide the 28VDC necessary for the system to operate.

*Control Board* - This component (located on the inside of the upper cabinet door) controls the key functions of the Vortex system including:

Tone Generation	Remote Activation
Remote Station Status Reporting* (encoding)	Event Timing
System Diagnostics (incl. SI TEST®)*	Local Control

\* optional equipment

The control board contains a serial port to allow connection of a palm computer (hereafter referred to as a PalmPC) to the remote station. The control board is also the location of the diagnostic LED's.

*Radio Board or Landline Board (Optional)* - This component (located on the inside of the upper cabinet door) receives signals from either the antenna or landline and delivers them to the control board for processing. Through the use of the included radio, the station is also capable of transmitting status information back to the control center.

*Motherboard* - This component (located on the inside of the upper cabinet door) distributes Battery Voltage and signals to all system components that require this voltage. The motherboard is fused @10 Amps to protect all connected components EXCEPT for the siren amplifiers and the rotor (they contain their own fuse).

*Antenna Poly Phaser (optional)* - This component suppresses high-voltage (static) charges that could be present on the antenna.

*Rotor Oscillator/Speaker Output Board* - This component (located on the inside of the upper cabinet wall) activates the rotor motor after receiving commands from the control board. This board also provides speaker output signals for the siren amplifiers.

This component is fused @20Amps.

*AC Duplex Outlet Housing* - This component (located on the left cabinet wall), as wired by the customer, provides a 110 VAC service to the battery charger by way of a 15A outlet.

*Siren Driver* - This component (located in the speaker assembly) produces the desired audible tone. Vortex3 systems use 3 drivers; Vortex4 systems use 4.

*Status LED's* - This component (visible through the right-side cabinet wall) duplicates the 5 status LED's (AC, DC, Partial, Full & Rotor) located on the controller board. This allows for visual confirmation of station status without having to open the cabinet doors (see "Fig. 18: System LED Diagnostic Indicators" on page 33)

*Antenna (optional)* - This component (located on the utility pole) is capable of either receiving signals broadcast from the control center (one-way) or can both transmit and receive signals to and from the control center (two-way), depending how the system was ordered.

*Solar Panel (optional)* - This component (located on the utility pole) collects solar energy, converts it to electrical energy and delivers it to the Solar Regulator to maintain the station batteries at their proper voltage.

*Intrusion Alarm (optional)* - This sensor (located on the door jam of the upper cabinet door) detects the opening of the cabinet door. If the station is equipped with this option, the alarm is configured to transmit a signal back to the control center.

## **Section VII: System Operations**

### **a) Remote Operations**

Remote operation of a Vortex series siren involves transmitting signals from the control center to the desired station. This is accomplished by using either an encoder and transmitter or, if the station is so equipped, using an aux-in board that has been wired to switches/controls at the control center. Remote operation is beyond the scope of this document and will therefore not be addressed. If your system is equipped with an encoder, please refer to the encoder operating manual for information regarding remote operation. If your station has been wired to use the auxiliary control status board, refer to the reference materials provided by the electrical engineer or installer.

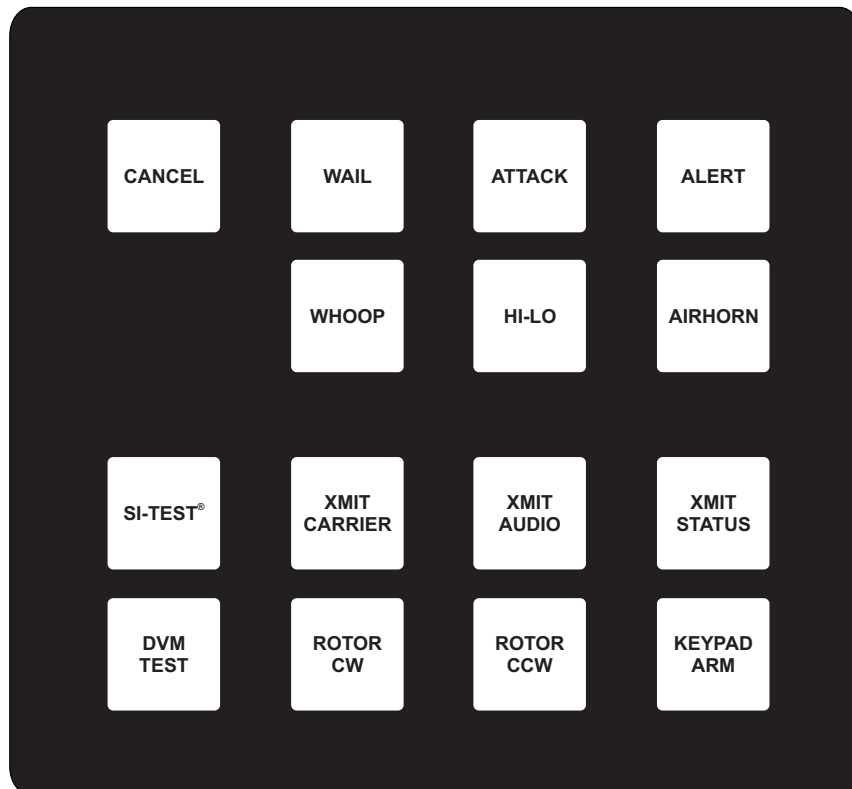
### **b) Local Operations**

Local operation is accomplished through the control panel on the front of the station cabinet. The functions of these controls are as follows:

Cancel	Abruptly stops siren tones without the normal “ramp down” found in several tones. Helpful in the event of an accidental tone activation.
Wail	Produces a slow rise and fall tone.
Attack	Produces a faster rise and fall tone (used for designated Civil Defense National Attack tone).
Alert	A steady tone (Civil Defense alert).
Whoop	A repetitive rise-only tone.
Hi-Lo	An alternating two-tone sound.
Air Horn	A pulsing air horn sound.
SI TEST®	Initiates SI TEST® tone and the optional diagnostic SI TEST® routine.
Xmit Carrier	Causes the siren radio to key and transmit without any test tone. When tone squelch is used with the transmitter, the transmit carrier function is used to test/verify tone/digital squelch modulation. Once pressed, the transmitter will remain keyed for 15 seconds before timing out.

Xmit Audio	Causes the siren radio to key and transmit with a steady DTMF test tone. This function is used to test/verify siren DTMF audio transmit modulation. Once pressed, the transmitter will remain keyed for 15 seconds.
Xmit Status	Transmits station status information and battery voltage to the control center
DVM Test	This function is not available in Vortex systems.
Rotor CW	This function is not available in Vortex systems.
Rotor CCW	This function is not available in Vortex systems.
Keypad Arm	Enables local station operation via keypad. Once pressed, the keypad remains active until either a) another keypad button is pressed, or b) 60 seconds have elapsed, whichever comes first. The Keypad Arm button must be pressed each time a keypad button is to be pressed. Note that the Cancel button is always enabled and does not require Keypad Arm to be pressed.

**Fig. 20: Station Control Panel**



## Section VIII: Understanding Station Addressing

Every Siren Station in a given area code has its own, unique “Station Address”. This address allows the user to select an individual or a group of stations. As stated elsewhere in this manual, a valid station address can be any number from 0000 to 9999. This allows for 10,000 unique addresses; a staggering number of stations to keep track of. Although it is logistically impossible to have that many stations in a single area code, it does illustrate the importance of a sensible, intuitive numbering convention for station addresses. This section will outline two types of conventions

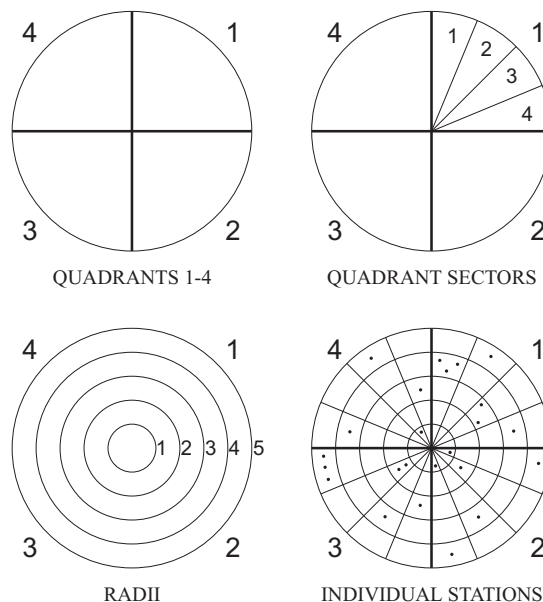
### **a) Central Point Source: Quadrant, Sector, Radial & Station**

Frequently, warning systems are used to notify the public of emergency situations that may occur from a single, centralized location. Typically, siren stations would be located throughout a 360° area surrounding this location for a specified distance from the source. In this scenario, the Central Point Source convention would be well suited.

For illustration purposes, assume the siren stations are installed within a 5 mile radius of the Central Point. As such, a Quadrant, Sector, Radial & Station numbering convention would allow the selection of any of the following:

- **any siren station**
- **all siren stations**
- **any one of four sectors**
- **any one of 5 radii within the sectors**

The area of coverage in this system, a circle, is divided into 4 quadrants. Each quadrant is then divided into 4 sectors. Each sector is further divided into 5 segments or radii emanating from the center of this siren system.





In this system, a stations address is structured as follows:

<u>Digit</u>	<u>Allocation</u>
1	Quadrant (1 to 4)
2	Sector (1 to 4)
3	Radii (1 to 5)
4	Individual station within a radian

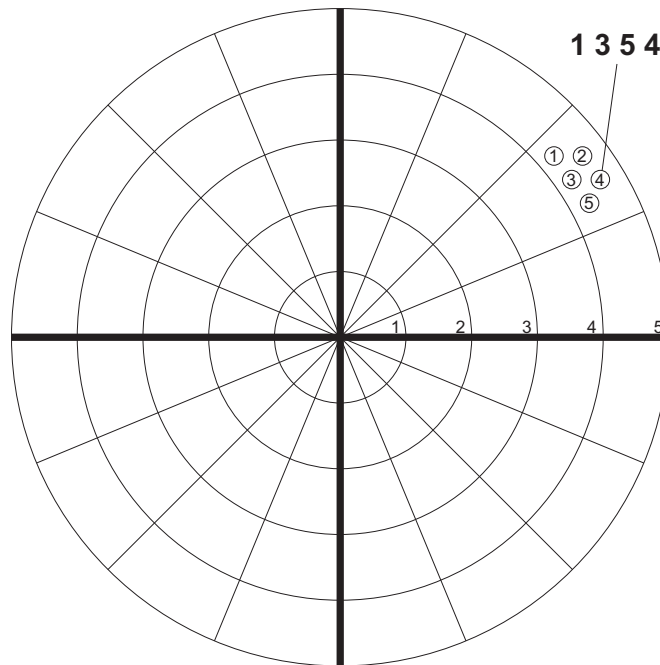
Here are some sample activations to further illustrate this concept.

**Sample 1:**

**A station with address 1354 would be located in:**

- Quadrant:** 1
- Sector:** 3 of Quadrant 1
- Radial:** 5
- Station:** 4

If an operator selects station 1-3-5-4, only that station will be selected, as shown.



**SINGLE STATION SELECTION  
STATION 1354**

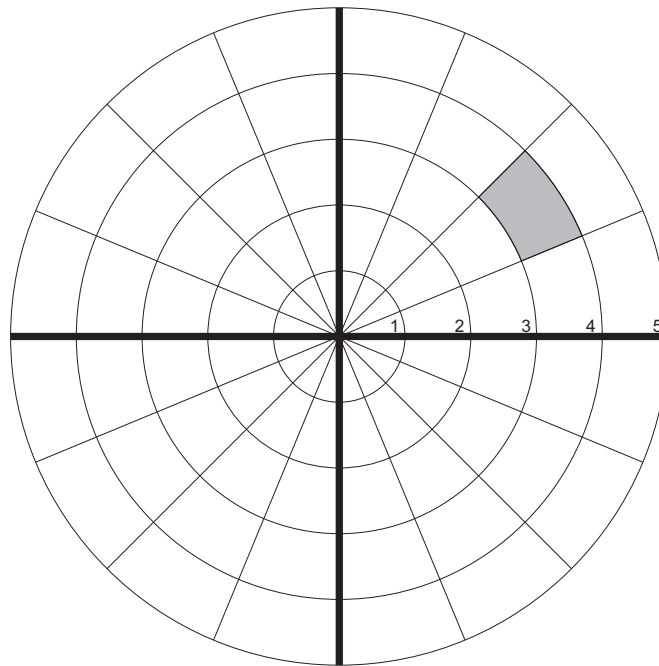
**Sample 2:**

If the activation of a group of remote stations within a whole segment of a radius within a quadrant and sector is desired, the fourth digit address is substituted with a “Wild Card”, the “#” pound sign.

An address selection of 1 - 3 - 4 - # would activate the system as follows:

- Quadrant: 1**
- Sector: 3 of Quadrant 1**
- Radial: 4**
- Station: # All stations defined by above**

This selection is shown below.



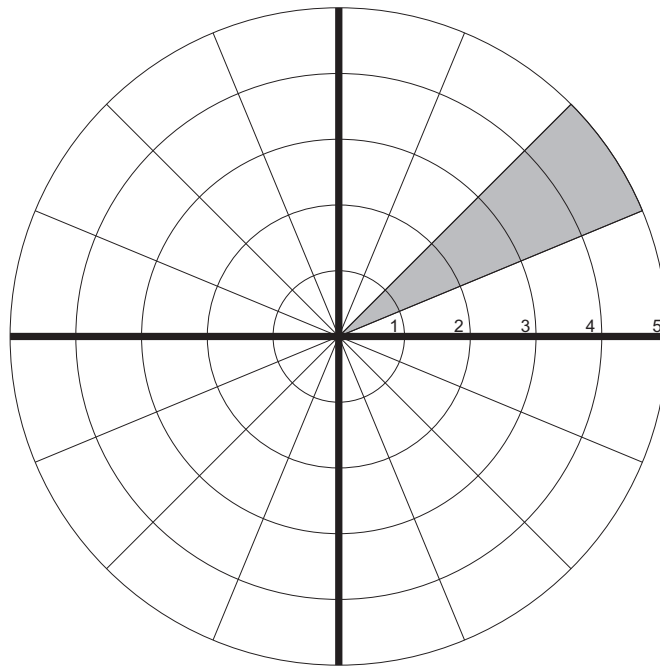
**GROUP SELECTION-RADIAL SECTOR  
GROUP 134#**

**Sample 3:**

**Selection of an entire sector can be accomplished by using the following address:**

- Quadrant: 1**
- Sector: 3 of Quadrant 1**
- Radial: # All radial 1 - 3**
- Station: # All stations defined by above**

**In selecting a sector, the first two digits of the address are set for the sector address, for example 1 - 3 (Quadrant 1 - Sector 3). The third and fourth digits are substituted with a # (Wild Card). Therefore, the address to select all stations in sector 1-3 is 1 - 3 - # - #. This selection is represented below.**



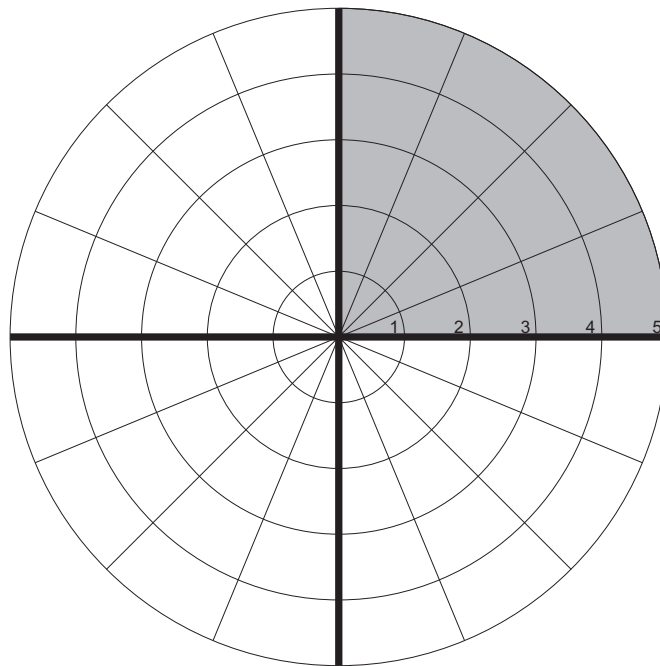
**GROUP SELECTION-SUB-SECTOR  
GROUP13##**

**Sample 4:**

The selection of a complete quadrant can be achieved by using the following address:

- Quadrant:** 1
- Sector:** # All sectors of Quadrant 1
- Radial:** # All radials in 1 - 3
- Station:** # All stations defined by above

When selecting a quadrant, the first digit designates the Quadrant (1). the second, third and fourth digits are replaced with Wild Cards (#,#,#). Therefore, the address for selecting all stations in quadrant 1 is 1 - # - # - # as illustrated below.



GROUP SELECTION-QUADRANT  
GROUP###

**Sample 5:**

All stations in a system may be accessed by using the Wild Card (#) for all address numbers.  
The address would be # - # - # - #.

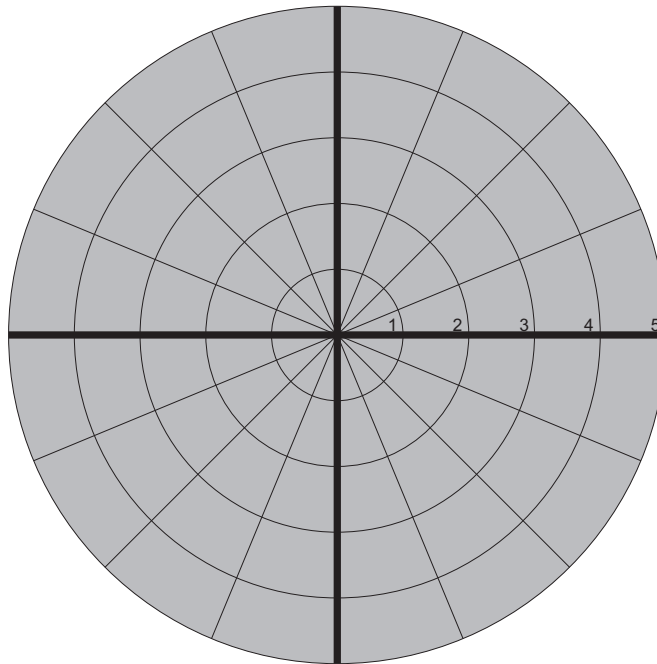
**Quadrant:** # All Quadrants

**Sector:** # All sectors of all Quadrant

**Radial:** # All radials

**Station:** # All stations defined by above

This “All Call” is illustrated as shown.



GROUP SELECTION-“ALL-CALL”  
GROUP #####

**b) Governmental: County, City & Station**

For this next type of address structure, assume that the siren system in question is used primarily for tornado warnings throughout a major population center. This center encompasses three counties with each county having no more than ten cities. Two cities contain more than 50 high-power voice and siren stations.

The following represents a Governmental System 4-digit address configuration, allowing activation by “All Call”, county group activations, city group activations and individual station activations:

<b>X</b>	<b>X</b>	<b>X</b>	<b>X</b>
:	:	:.....:..... <b>Individual Siren Station (0 - 9)</b>	
:	:		
:	:..... <b>City (0 - 9)*</b>		
:			
:..... <b>County (0 - 9)</b>			

**\*One digit could also be reserved for unincorporated areas.**

An address of 2 - 5 - 4 - 5 would indicate the following individual station:

Siren Station 45, in City 5, in County 2.

The Wild Card (#) permits the use of several different types of group activations. Three samples follow:

**Sample 1: County Activation (1 - # - # - #)**  
**All Siren Stations in all Cities in County 1 will be activated by this transmission.**

**Sample 2: City Activation (1 - 5 - # - #)**  
**All Siren Stations in City 5 of County 1 will be activated by this transmission.**

**Sample 3: System All Call (# - # - # - #)**  
**All Siren Stations in all Cities in all Counties will be activated by this transmission.**

# **CHAPTER 3: TROUBLESHOOTING**

## **Section IX: Troubleshooting**

### **a) Audio Loss**

If after activating the siren there is no audio output, perform the following procedure step by step. This procedure will require a digital multimeter.

1. Locate the Audio Presence LED on the controller board (see “Fig. 18: System LED Diagnostic Indicators” on page 33). When audio is present on the board, this LED will be on.
2. Activate the WAIL siren tone from the control panel on the siren cabinet. Confirm that the Audio Presence LED is on. If this LED is not on *or* if it turns off quickly, measure the battery voltage. The siren will not activate if battery voltage drops below 19 VDC. Be sure to measure the battery voltage at the same time you activate the siren. The batteries may show a good float voltage while they are not under load, but upon activation, the battery voltage may drop below 19 VDC if their capacity is low. Note that when the siren shuts down and the load is removed from the batteries, the voltage may rapidly return to 25 VDC or more. If this condition is occurring, the batteries will need to be replaced. If the voltages are in the normal range, proceed to step 3.
3. Locate connector J2 on the control board. With your multimeter set to AC volts, measure across pins 6 and 7 (White with Orange stripe and White with Brown stripe). With the siren tone running, 5 VAC should be present. *If no voltage is present, the controller board is probably at fault.*  
NOTE: Confirm that the audio presence LED is on while performing these measurements. It indicates that the siren controller is still activated. If the specified voltages are present, proceed to step 4.
4. With the siren tone still active, measure across pin 1 (Blue wire) and pin 2 (Black w/White trace) on each of the siren amplifiers. 5 VAC should be present at each amplifier. If so, proceed to step 5. If no voltage is measured, this is indicative of a wiring problem between the controller board and the siren amplifiers. Check the wiring between these components
5. Set your meter to measure resistance at its lowest scale. Disconnect the speaker drivers from their amplifiers. Measure across each of the speaker drivers, making sure that at least one wire of each driver is removed from the power amplifier (or else the transformer in the amp is being measured as well). Each driver should have a DC resistance of approximately 3 Ohms +/- .3 Ohms. If a resistance value outside of this range is found, contact factory.



6. Set your meter to measure DC Volts. Connect the negative lead of your meter to ground (one of the solid black wires in the multi-position connector on the amplifier is a good ground source). With a siren tone activated, measure the following wires for the following voltages (approximately):

<u>Wire</u>	<u>Proper Voltage</u>	<u>If not...</u>
<b>Grey</b>	<b>9 VDC</b>	<b>Controller Board is suspect</b>
<b>Brown</b>	<b>7 VDC</b>	<b>Controller Board is suspect</b>
<b>Solid White (all)</b>	<b>24 VDC</b>	<b>30A Fuse On Motherboard Amp is suspect</b>

### **b) AC Battery Charger**

The Vortex is basically a 24 volt DC battery powered device. An internal battery charger maintains the batteries at an optimum charge level. The charger incorporates a temperature compensation circuit to insure proper charging regardless of outside temperature.

There are two (2) serviceable fuses on the battery charger. The AC fuse is a 7 amp, SLO-BLO, 3AG type, and the DC charge out fuse is a 7.5 amp, auto type.

### **c) Solar Regulator**

The following procedure can be performed to confirm proper operation of the solar regulator:

1. Disconnect the solar panel from the charger. With a DC voltmeter, measure the voltage across the wires coming from the solar panel. The voltage should be greater than 32 VDC (NOTE: The solar panel must be in direct sunlight).
2. Reconnect the solar panel to the charger. Monitor the battery voltage with the cabinet voltmeter. The float voltage will vary between 25 to 30 VDC, depending on battery temperature. When the solar regulator is charging, the DC LED on the circuit board will be on. During normal operation the charger will cycle on and off.

#### **d) Partial or Full Diagnostic Failure**

This procedure is to be used if the Partial or Full diagnostic LED (located on the controller board) indicates that a problem has been detected. A Partial indication means that at least one speaker and/or amplifier is operational. A Full indication means that all speakers and amplifiers are operational.

**Note:**           **In order for a good Full indicator to be valid, a good Partial indicator must also be present).**

1.     Connect the PalmPC to the siren station *via* the com port on the front of the siren cabinet control panel.
2.     Display the “Status” screen on the PalmPC.
3.     Press the SI TEST® control on the front control panel.
4.     Each amplifier contains a red LED that is visible on the front of the control panel. Note if all the LED’s are on. Tap the “Update Status” button on the PalmPC and note which amp is displaying an error.
5.     Open the front panel and swap the speaker driver wires from the amplifier that indicated a failure, with an amplifier with a lit LED. For example: if the LED for amplifier 1 is the only LED not on, install amplifier 1 speaker wires onto amplifier 2 and install amplifier 2 speaker wires onto amplifier 1. This will diagnose if it is the speaker or the amplifier that has failed. You may also measure the DC resistance of the speaker driver with your ohm meter. Be sure that the speaker driver wires are disconnected from the amp prior to measuring. A good driver will read 3 ohms +/- .3 ohms.

## **Section X: Maintenance**

Although The Vortex is of a dependable, solid-state design, periodic activation, field inspection and preventive maintenance is recommended to insure the maximum performance of each station.

### **a) Frequency of Testing and Activation**

A system of twice-monthly activation and confirmation, combined with a quarterly service and preventive maintenance is recommended to help insure the successful performance of a station. Increasing the frequency of testing will support and improve a station's test record.

Stations located in environmentally adverse locations will require inspection and preventive maintenance at more frequent intervals than just discussed. Stations should always be inspected following severe storms.

If a station is activated by remote control (landline or radio), the twice-monthly activation should be performed using the remote control link.

The twice-monthly activation of a station can be confirmed by several different methods, depending upon the options selected with each Whelen System.

### **b) Local Site Confirmation**

For a basic station activated at the cabinet, or by landline or radio, have an observer confirm that the station activated audibly. The observer should report successful as well as failed station tests. Station Performance Logs should be maintained. It is important to understand that audible confirmation alone is not assurance that the station is operating at 100% power. This requires inspecting the station in greater detail.

Stations may be optionally equipped with counters that advance upon radio or tone generator activation. These counters do not confirm total operation or the final expected output of an outdoor warning device.

The station's activation may be confirmed using SI TEST® or full power siren mode. Following an activation, SI TEST® displays its information on control board mounted LED's or through a LED display board visible on the right side of the cabinet. Fig. 15 (page 33) shows the location and function of the LED's on the control board. The cabinet mounted display board LED's will confirm the following (from Left to Right):

<b>Red</b>	<b>AC Power</b>
<b>Yellow</b>	<b>DC Power at minimum proper operating level</b>
<b>Red</b>	<b>Partial Amplifier and Speaker Driver Operation</b>
<b>Green</b>	<b>Full Amplifier and Speaker Driver Operation</b>
<b>Red</b>	<b>Rotor Operation</b>

Following activation and observation the results should be noted in the performance log. Any indication of incomplete operation presented by the LED indicators should prompt IMMEDIATE service attention.

The SI TEST® system retains information until cleared by a specific command.

The SI TEST® information stored at the station, if not cleared, will update itself automatically with subsequent SI TEST® activations.

### **c) Remote Monitoring and Confirmation**

Stations equipped with the optional Whelen COMM/STAT™ Command and Status Monitoring control, allow remote monitoring of status as well as confirmation of system activation. COMM/STAT™ returns the results of a remote station activation (both SI TEST® and siren warning mode) in a DTMF encoded format via radio link.

Remote monitoring by RF link eliminates the necessity of physically visiting a station to confirm an activation.

Following the activation of a station, a “Status Request” may be sent to that station by DTMF encoded radio command. Diagnostic SI TEST® information is then presented to the status encoder at the station, converted into DTMF code and transmitted back to the control center, where one of several COMM/STAT™ base station products will convert the DTMF code into meaningful information.

### **d) Quarterly Maintenance**

Developing a quarterly inspection and preventive maintenance program for an outdoor warning station requires a thorough understanding of all the elements and expectations of the system. The following section provides an overview and basic guideline for quarterly station inspection and preventive maintenance program for the sample station.

#### **e) Visual Siren Station Physical Inspection**

- **Observe the speaker cluster, siren cabinet and AC Service for any signs of damage or loose mounting hardware (Some shrinkage of a newly treated utility pole may occur in the first several years following installation, requiring the tightening of mounting hardware.**
- **Check all conduit for watertight connection and entrance into the siren cabinet.**
- **Inspect the AC Service for damage, blown fuses, degraded (corroded) power connections and integrity of the lightning arrester.**
- **Inspect the grounding system for AC Service, Siren Cabinet and pole top equipment. Verify connections and acceptability of earth ground.**
- **Observe the pole for any shifting and/or leaning. Poles that are not plumb will not properly direct alerting sounds.**
- **Examine entire station for any signs of vandalism or forced entry.**

#### **f) Siren Cabinet and Components**

- **Inspect AC Outlet, fuse and surge suppression equipment. Examine system for infiltration of foreign material(s), rodents or other pests.**
- **Inspect and, if necessary, clean all drain holes and vent screens.**
- **Inspect battery terminal connections and clean if necessary. Re-apply silicone coating to battery terminals if necessary. Observe battery voltage with siren in inactive state (AC power must be on to station, otherwise station must be powered up to observe meter).**
- **Examine all wiring harnesses for chafing. Verify wiring terminations for tightness and wiring connections for proper electrical connections. Replace and correct any corroded or marginal connections. Inspect antenna for proper connection.**

#### **g) Speaker Assembly and Pole Top Equipment**

**Note:** Any examination of Pole Top equipment should be performed with the station audibly disabled.

- **Inspect speaker for blockage by rodents, pests or other foreign material. Clean if necessary. Inspect any wiring cables or harnesses for chafing. Inspect the siren driver compartment for infiltration of foreign materials, rodents or pests. Clean if necessary. Confirm that the driver compartment will allow for water or moisture drainage. Inspect speaker wiring connections for any sign of corrosion.**

- **Verify tightness of all mounting hardware.**
- **Check all wiring terminations and connections.**
- **Verify lubrication of the rotor gear train. The recommended inspection interval is initially 6 months. Following the initial two inspections, the owner may determine if a longer inspection interval is acceptable. Varying weather conditions will affect this interval. Many stations are located in areas of the country where an annual inspection/lubrication interval is acceptable.**

## **h) Station Performance Testing**

**Note:**            **Depending on local conditions and station options selected, the station may be tested on or off line. Off line testing of the station involves disconnecting the speaker drivers from the siren amplifiers, so as not to disturb the public when verifying tone generator operation. A complete test must, however, include the testing of the siren amplifier operation.**

A basic routine, verifying the performance and operation of the sample station previously described, would be as follows:

1.     **Local and Remote Activation -**

Activation of each remote station function by local control and remote control. With amplifiers on and off line as needed. An examination of each activation function will also facilitate a verification of related and subsequent system module activations and electrical connections that would be caused by an activation command. Also confirm function time outs (ex.: does the Alert signal time out at three minutes as per user specification?).

2.     **Response to Station Address and All Call address programming -**

Control Center reception and activation on SI TEST® or non-tone activation, for individual station address and All Call address selection.

3.     **Siren Amplifiers -**

Inspect for complete operation with speaker drivers (observe LED's).

4.     **SI TEST® Station Analysis -**

Observe and confirm diagnostic status of:

AC

DC

Partial Amplifier & Speaker Driver Operation (disable one amplifier to confirm this test).

Full Amplifier & Speaker Driver Operation

*Verify AC drop out during SI TEST® mode.*

5. Battery Charger Operation -

Observe for proper charging operation.

6. Batteries -

Verify voltage stability under load.

Perform a load test.

7. Status Encoder -

Perform a diagnostic SI TEST® of the station and compare status information with observations made locally at the station.

Disable one speaker and verify that the “Full” LED indicator is off.

Disable AC and verify that the “AC” LED indicator is off.

Compare battery voltage return status with observed and measured battery voltage.

8. Transmitter -

Check status encoder DTMF tone level modulation with transmitter.

Check transmitter set up.

Verify power output and SWR.

9. Rotor -

Activate the siren with Si-test™ or tone and verify speaker rotation. Speaker should oscillate back and forth.

**Note: On concluding any examination of a station where connectors have been opened and closed, a final radio test by either SI TEST® or full power should be performed and the results observed for a complete successful test.**

The following is a sample form that may be used for quarterly inspection and maintenance.

**MAINTENANCE CHECK LIST**

Station #: \_\_\_\_\_

Siren Address: \_\_\_\_\_

Installation Date: \_\_\_\_ / \_\_\_\_ / \_\_\_\_

Inspection Date: \_\_\_\_\_

Inspector: \_\_\_\_\_

**PHYSICAL INSPECTION:**

	<b><u>OK</u></b>	<b><u>NOT OK</u></b>	<b><u>COMMENT</u></b>
Mounting Hardware	___	___	_____
Speaker Assembly	___	___	_____
AC Service	___	___	_____
Proper Grounding	___	___	_____
Solar Panels*	___	___	_____
Antenna*	___	___	_____
Conduit Connections	___	___	_____
Siren Case Assembly	___	___	_____
Batteries	___	___	_____
Components Secure	___	___	_____
Harnesses	___	___	_____

**LOCAL OPERATIONAL TESTING**

Battery Float Voltage	___	___	_____
Battery Loaded Voltage	___	___	_____
<b>Manual Test:</b>			
Keypad Arm	___	___	_____
Cancel	___	___	_____
Wail	___	___	_____
Attack	___	___	_____
Alert	___	___	_____
Airhorn	___	___	_____
Hi-Lo	___	___	_____
Whoop	___	___	_____
<b>(SI TEST®):</b>			
AC LED	___	___	_____
DC LED	___	___	_____
Partial LED	___	___	_____
Full LED	___	___	_____
Rotor LED	___	___	_____
Audio Present LED	___	___	_____



**MAINTENANCE CHECK LIST**

**(continued)**

**Radio\*:**

	<b><u>OK</u></b>	<b><u>NOT OK</u></b>	<b><u>COMMENT</u></b>
Squelch Control	—	—	—
Sensitivity	—	—	—
Antenna Tuned*	—	—	—
Transmit LED	—	—	—

**Remote Activation:**

Cancel	—	—	—
Wail	—	—	—
Attack	—	—	—
Alert	—	—	—
Air Horn	—	—	—
Hi-Lo	—	—	—
Whoop	—	—	—
Noon Test	—	—	—
All Call	—	—	—

**Amplifier LEDs:**

1	—	—	—
2	—	—	—
3	—	—	—
4	—	—	—

**SI TEST®:**

AC	—	—	—
DC	—	—	—
Partial	—	—	—
Full	—	—	—
Status Request	—	—	—

**Intrusion\***

—	—	—
---	---	---

**\*Optional**

# VORTEX WIRING DIAGRAM

