

# WHELEN<sup>®</sup>

## ENGINEERING COMPANY INC.

51 Winthrop Road  
Chester, Connecticut 06412-0684  
Phone: (860) 526-9504  
Fax: (860) 526-4078  
Internet: [www.whelen.com](http://www.whelen.com)  
Sales e-mail: [autosale@whelen.com](mailto:autosale@whelen.com)  
Canadian Sales e-mail: [canadiansales@whelen.com](mailto:canadiansales@whelen.com)  
Customer Service e-mail: [custserv@whelen.com](mailto:custserv@whelen.com)

**Installation Guide:**  
**Siren Model(s)**  
**295SL100 (200W - 12V)**  
**295SL101 (200W - 12V (w/Removable Mic))**  
**295SL102 (200W - 24V)**

**DANGER!** Sirens produce extremely loud emergency warning tones! Exposure to these tones without proper and adequate hearing protection, could cause ear damage and/or hearing loss! The Occupational Safety & Health Administration ([www.osha.gov](http://www.osha.gov)) provides information necessary to determine safe exposure times in Occupational Noise Exposure Section 1910.95. Until you have determined the safe exposure times for your specific application, operators and anyone else in the immediate vicinity should be required to wear an approved hearing protection device. **FAILURE TO FOLLOW THIS RECOMMENDATION COULD CAUSE HEARING LOSS!**

### Warnings to Installers

Whelen's emergency vehicle warning devices must be properly mounted and wired in order to be effective and safe. Read and follow all of Whelen's written instructions when installing or using this device. Emergency vehicles are often operated under high speed stressful conditions which must be accounted for when installing all emergency warning devices. Controls should be placed within convenient reach of the operator so that they can operate the system without taking their eyes off the roadway. Emergency warning devices can require high electrical voltages and/or currents. Properly protect and use caution around live electrical connections. Grounding or shorting of electrical connections can cause high current arcing, which can cause personal injury and/or vehicle damage, including fire. Many electronic devices used in emergency vehicles can create or be affected by electromagnetic interference. Therefore, after installation of any electronic device it is necessary to test all electronic equipment simultaneously to insure that they operate free of interference from other components within the vehicle. Never power emergency warning equipment from the same circuit or share the same grounding circuit with radio communication equipment. All devices should be mounted in accordance with the manufacturer's instructions and securely fastened to vehicle elements of sufficient strength to withstand the forces applied to the device. Driver and/or passenger air bags (SRS) will affect the way equipment should be mounted. This device should be mounted by permanent installation and within the zones specified by the vehicle manufacturer, if any. Any device mounted in the deployment area of an air bag will damage or reduce the effectiveness of the air bag and may damage or dislodge the device. Installer must be sure that this device, its mounting hardware and electrical supply wiring does not interfere with the air bag or the SRS wiring or sensors. Mounting the unit inside the vehicle by a method other than permanent installation is not recommended as unit may become dislodged during swerving; sudden braking or collision. Failure to follow instructions can result in personal injury. Whelen assumes no liability for any loss resulting from the use of this warning device. **PROPER INSTALLATION COMBINED WITH OPERATOR TRAINING IN THE PROPER USE OF EMERGENCY WARNING DEVICES IS ESSENTIAL TO INSURE THE SAFETY OF EMERGENCY PERSONNEL AND THE PUBLIC.**

### Warnings to Users

Whelen's emergency vehicle warning devices are intended to alert other operators and pedestrians to the presence and operation of emergency vehicles and personnel. However, the use of this or any other Whelen emergency warning device does not guarantee that you will have the right-of-way or that other drivers and pedestrians will properly heed an emergency warning signal. Never assume you have the right-of-way. It is your responsibility to proceed safely before entering an intersection, driving against traffic, responding at a high rate of speed, or walking on or around traffic lanes. Emergency vehicle warning devices should be tested on a daily basis to ensure that they operate properly. When in actual use, the operator must ensure that both visual and audible warnings are not blocked by vehicle components (i.e.: open trunks or compartment doors), people, vehicles, or other obstructions. It is the user's responsibility to understand and obey all laws regarding emergency warning devices. The user should be familiar with all applicable laws and regulations prior to the use of any emergency vehicle warning device. Whelen's audible warning devices are designed to project sound in a forward direction away from the vehicle occupants. However, because sustained periodic exposure to loud sounds can cause hearing loss, all audible warning devices should be installed and operated in accordance with the standards established by the National Fire Protection Association.

### Safety First

This document provides all the necessary information to allow your Whelen product to be properly and safely installed. Before beginning the installation and/or operation of your new product, the installation technician and operator must read this manual completely. Important information is contained herein that could prevent serious injury or damage.

- Proper installation of this product requires the installer to have a good understanding of automotive electronics, systems and procedures.
- Whelen Engineering requires the use of waterproof butt splices and/or connectors if that connector could be exposed to moisture.
- Failure to use specified installation parts and/or hardware will void the product warranty.
- If mounting this product requires drilling holes, the installer **MUST** be sure that no vehicle components or other vital parts could be damaged by the drilling process. Check both sides of the mounting surface before drilling begins. Also de-burr the holes and remove any metal shards or remnants. Install grommets into all wire passage holes.
- If this manual states that this product may be mounted with suction cups, magnets, tape or Velcro®, clean the mounting surface with a 50/50 mix of isopropyl alcohol and water and dry thoroughly.
- Do not install this product or route any wires in the deployment area of your air bag. Equipment mounted or located in the air bag deployment area will damage or reduce the effectiveness of the air bag, or become a projectile that could cause serious personal injury or death. Refer to your vehicle owner's manual for the air bag deployment area. The User/Installer assumes full responsibility to determine proper mounting location, based on providing ultimate safety to all passengers inside the vehicle.
- For this product to operate at optimum efficiency, a good electrical connection to chassis ground must be made. The recommended procedure requires the product ground wire to be connected directly to the NEGATIVE (-) battery post (this does not include products that use cigar power cords).
- If this product uses a remote device for activation or control, make sure that this device is located in an area that allows both the vehicle and the device to be operated safely in any driving condition.
- It is recommended that these instructions be stored in a safe place and referred to when performing maintenance and/or reinstallation of this product.
- **FAILURE TO FOLLOW THESE SAFETY PRECAUTIONS AND INSTRUCTIONS COULD RESULT IN DAMAGE TO THE PRODUCT OR VEHICLE AND/OR SERIOUS INJURY TO YOU AND YOUR PASSENGERS!**

**ACTIVATION OF THIS  
SIREN MAY DAMAGE  
UNPROTECTED EARS!**



**CAUTION**  
Loud siren noise can cause hearing damage and/or loss. Refer to OSHA Section 1910.95 prior to putting ANY siren into service!

Congratulations on selecting the 295SL10 Series Siren! This series offers a unique and distinctive collection of features designed to allow the user to customize the operation of this siren to suit their individual wants or needs.

- Power to drive two, 100-Watt speakers.
- Scan-Lock™ Tone Programming
- Hands-Free operation.
- Radio Repeat.
- Auxiliary Input Control
- Horn ring Transfer
- Simulated mechanical siren tones.
- Harmonically-rich, composite Airhorn tones.
- Title 13-compliant profiles.
- Compact Size

## Mounting

The 295SL10 is designed to be mounted directly onto the dash or other surface through the use of a bail strap mounting bracket. The unit may also be mounted into your vehicle's console (if so equipped). **Regardless of the style selected, be sure to observe the air-bag warning on the cover of this manual.**

### Bail Strap Mount

1. Position the bail strap in the selected mounting location. Using an awl or other suitable tool, scribe the surface where the mounting holes are to be drilled.

**Caution:** As mounting this unit will require drilling, it is absolutely necessary to make sure that no other vehicle components could be damaged in the process. Check both sides of the mounting surface before starting. If damage is likely, select a different mounting location.

2. Drill the mounting holes in the areas scribed in step 1. The size of the drill bit should be determined by the size of the mounting hardware used and thickness of the mounting surface.

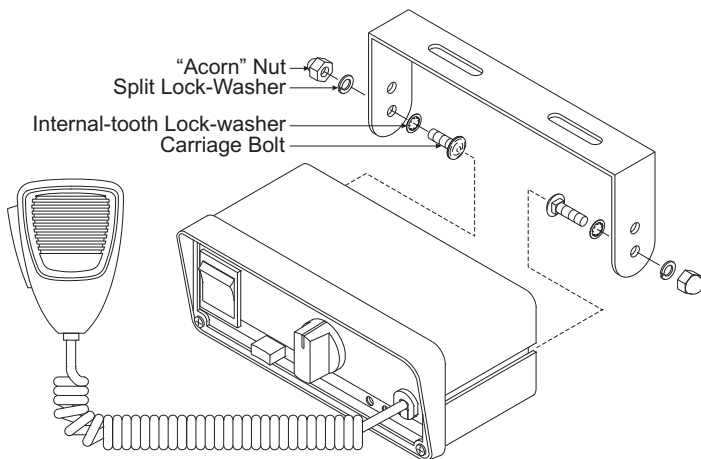

3. Secure the bail strap to the mounting location.

**Note:** There are 2 sets of holes on the bail strap for positioning the unit at 2 different heights.

4. Secure the siren to the bail bracket using the provided hardware as shown below.
5. Tighten the Acorn nut firmly.

### Console Mount

Console manufacturers offer mounting kits that include all the necessary hardware and brackets required to mount this unit into their console. The console mount brackets are secured onto the unit the same way the bail bracket is (except for the addition of two flat washers that must be inserted between the siren and the bracket). Please refer to the manual included with your console for specific information on securing the siren/mounting bracket assembly onto the console.

**NOTE:** Due to the lack of air flow within a console, prolonged operation of this siren will require the console to be modified to improve ventilation.

**IMPORTANT AIR BAG WARNING!** Do not install this product or route any wires in the air bag deployment zone of your vehicle. Equipment mounted or located in air bag deployment zones will damage or reduce the effectiveness of the air bag, or become a projectile that could cause serious personal injury or death. Refer to your vehicle owners manual to learn the air bag deployment zones for the vehicle. The User/Installer assumes full responsibility to determine proper mounting location, based on providing ultimate safety to all passengers inside the vehicle.

# Wiring:

## Power & Ground Wires: RED: Power / BLACK: Ground

**WARNING!** All customer supplied wires that connect to the positive terminal of the battery must be sized to supply at least 125% of the maximum operating current and FUSED at the battery to carry that load. **DO NOT USE CIRCUIT BREAKERS WITH THIS PRODUCT!**

1. Splice the 2 RED (Power) wires together, then extend this single RED wire toward the vehicle battery. Splice the 2 BLACK (Ground) wires together and extend this single BLACK wire toward the vehicle battery. To pass the RED and BLACK wires through, you may have to drill a hole in the firewall. Be sure there are no components that could be damaged. Insert a grommet in the hole to protect the wires.
2. Route the RED and BLACK wires along the factory harness towards the battery and install a fuse block (user supplied) on the end of the RED wire (refer to the wiring schematic on page 4 for your model's fuse value). **NOTE:** Remove the fuse from the fuse block before connecting any wires to the battery.
3. Connect the fuse block wire to the POSITIVE (+) terminal on the battery. There must not be more than 2 feet of wire between fuse block and battery. The wire between the fuse and the battery is "unprotected." Do not allow it to contact with any wires.
4. Connect the BLACK wire to the factory chassis ground.

## Speaker Wires: ORANGE & BROWN

1. Route the ORANGE and BROWN wires toward the vehicle siren speakers, along the factory wire harness and through the firewall at the same point as the RED and BLACK wires.
2. Connect the ORANGE wire to the POSITIVE connection on speakers #1 & 2.
3. Connect the BROWN wire to the NEGATIVE connection on speakers #1 & 2.

## Horn Relay Wires: WHITE & GREY

1. Route the WHITE and GREY wires along the factory wire harness and through the firewall at the same point as the RED and BLACK wires.
2. Route the WHITE and GREY wires to your vehicle's horn relay. If possible, follow the factory wire harness to this relay.
3. Locate the wire that connects the vehicle horn to the horn relay and cut it.
4. Connect the WHITE wire to the wire coming from the horn relay.
5. Connect the GREY wire to the wire coming from the horn.

## Radio Rebroadcast (optional): 2 BLUE wires

The two remaining BLUE wires are used to connect your two-way radio's external speaker for radio rebroadcast (an optional connection).

**NOTE:** If your remote speaker is amplified (has a power amp circuit in the speaker), radio rebroadcast will not work and should not be enabled.

1. Locate the two wires that connect the external speaker to the two-way radio, cut one of them and splice one of the BLUE wires into this circuit.
2. Now cut the remaining speaker wire and splice the remaining BLUE wire into this circuit.

		Wire Gauge / AWG					
		12	10	8	6	4	2
Current Draw / AMPS	20	15.5	24.5	39	62	98.5	157
	30	10.5	16.5	26	41.5	66	104
	40	7.5	12.5	19.5	31	49.5	78.5
	50	6	10	15.5	25	39.5	63
	60	5	8	13	20.5	33	52.5
	70	4.5	7	11	17.5	28	45
	80	4	6	10	15.5	24.5	39

Distance is shown in feet.

Refer to this chart for the wire size for your application.

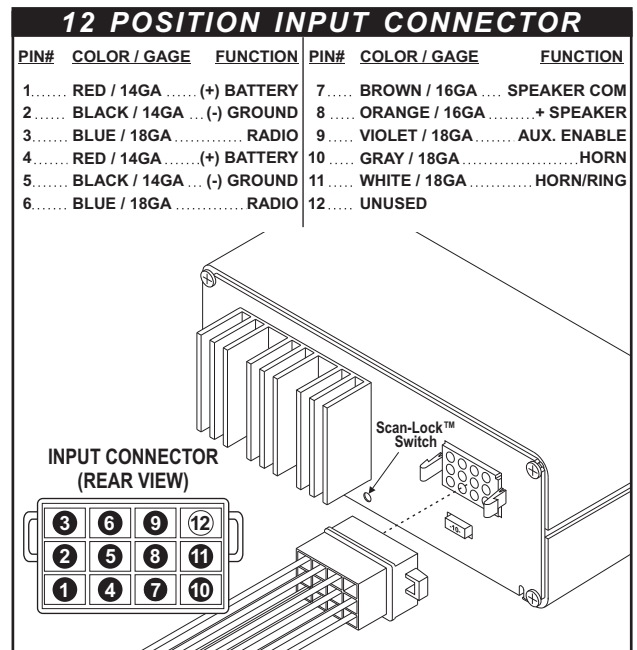

## Connecting to a Remote Control Head: (Optional)

This unit may be connected to an existing control head, such as the Whelen PCDS-9 or equivalent. This is an optional connection that enables the WAIL tone to be activated through the use of a PCDS-9 button or switch. If this connection is not chosen, cut the VIOLET wire and cap it to prevent accidental grounding of the wire.

## WIRING DIAGRAM

**NOTE:** All Fuses & Fuse Blocks are to be supplied by the Customer. **Do NOT use circuit breakers with this product!**

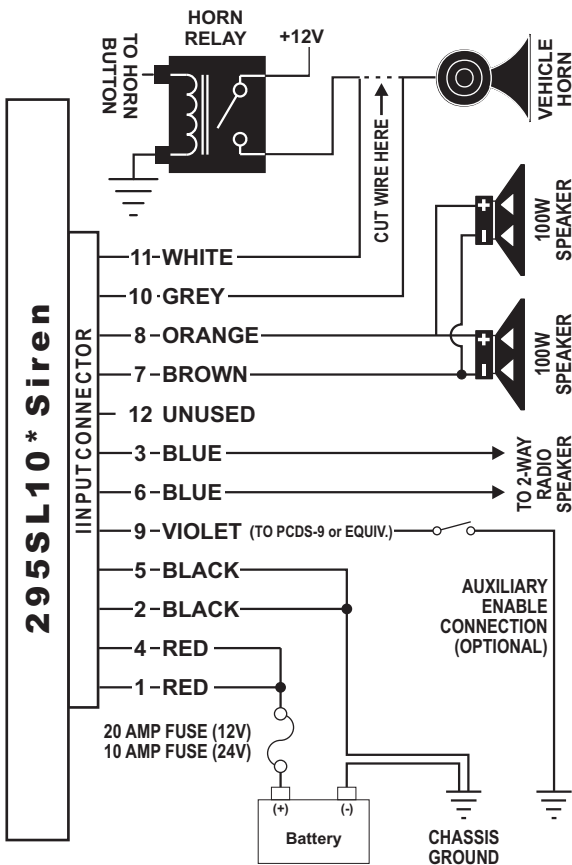

## OPERATING THE CONTROLS:

### POWER SWITCH

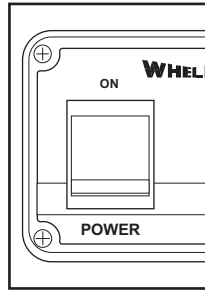

This switch has two positions: Down (Off) and Up (On). When this switch is Off, the unit will not function. When the switch is On, the siren is functional and may be activated at the operator's discretion. This switch also activates control head backlighting. **NOTE:** If the unit is connected to the vehicle's horn ring circuit, the vehicle horn is disabled when the power switch is in the ON position.

### ROTARY SWITCH

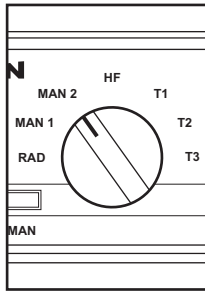

The rotary knob controls the siren functions. There are 7 positions that may be selected. Each position and its function is outlined under "Rotary Switch Operations."

### MAN BUTTON

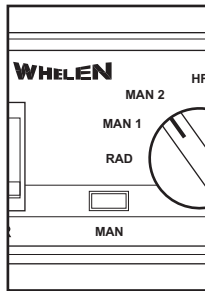

The Manual button generates a variety of tones, depending on what position the rotary knob is in. For further explanation of this button's function, refer to "Rotary Switch Operations."

### PA VOLUME (MIC)

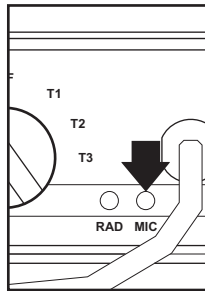

If your model uses a potentiometer, locate the MIC adjustment port as shown. With the vehicle in an enclosed area, turn the siren on and speak into the microphone. While speaking, insert the screwdriver and turn clockwise to increase the volume. Continue to increase the PA volume until audio feedback occurs. Turn the screwdriver counter-clockwise to eliminate feedback. For models with a PA Volume knob, follow the same procedure using the knob.

### RADIO REPEAT VOLUME (RAD)

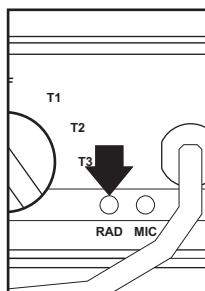

Locate the Radio Repeat adjustment port as shown. Set the volume level of the vehicle's two-way radio to its normal operating volume. Turn the rotary knob to RAD to activate Radio Repeat. Insert the screwdriver in the Radio Repeat adjustment port and turn clockwise to increase the volume.

## Rotary Switch Operations

This section will outline the operation of the siren in the **factory default configuration**. Refer to the Scan-Lock™ section on the following page for information and procedures on how to customize the operation of this siren.

**RAD (Radio Repeat)** - When the rotary knob is in the RAD position, any signal that is received by the vehicle's two-way radio will be simultaneously broadcast over the vehicle's loudspeaker (the unit must be connected to the two-way radio as outlined in this manual).

### With the Rotary Switch in this Position:

- Pressing the MAN button will produce the AIRHORN tone until the MAN switch is released.
- Activating the HORN RING input will produce the AIRHORN tone until the MAN switch is released.
- Activating the AUX ENABLE input has no effect.

**MAN 1 (Manual Siren #1)** - When the rotary switch is in this position the siren is in a standby state where no tones have been activated, but is waiting for another action to be taken by the operator.

### With the Rotary Switch in this Position:

- Pressing the MAN button will produce the AIRHORN tone until the MAN switch is released.
- Activating the HORN RING input will produce the AIRHORN tone until the HORN RING input is released.
- Activating the AUX enable input will produce a repeating WAIL tone.

**MAN 2 (Manual Siren #2)** - When the rotary switch is in this position the siren is in a standby state. No tones will be activated until another action is taken by the operator.

### With the Rotary Switch in this Position:

- Pressing the MAN switch will produce a WAIL tone. This tone will ramp up to peak frequency and stop when the MAN switch is released.
- Activating the HORN RING input will produce a WAIL tone. This tone will ramp up to peak frequency and stop when the HORN RING input is released.
- Activating the AUX enable input will produce a repeating WAIL tone.

**HF (Hands-Free Operation)** - When the rotary knob is in the HF position, the siren functions are placed in a stand-by mode. Siren tones are activated by a single "tap" on the MAN button or on the vehicle's steering wheel horn ring (if the vehicle's horn has been

wired to the HORN RING input). The first tap produces a Wail tone (a steady rise and fall tone). A second tap produces a Yelp tone (a fast rise and fall tone). A third tap produces a Piercer™ tone (an extremely fast rise and fall tone). The next tap returns the siren to a Wail tone and the cycle repeats itself. Two quick successive taps will stop the siren.

### With the Rotary Switch in this Position:

- Pressing the MAN button will produce the HF cycle as described above.
- Activating the HORN RING input will produce the HF cycle as described above.
- Activating the AUX ENABLE input will start the HF cycle. Releasing the AUX ENABLE will stop the cycle.

**T1 (Tone #1)** - When the rotary knob is in the T1 position, a steady, rise and fall tone (WAIL) is produced.

### With the Rotary Switch in this Position:

- Pressing the MAN button will change the siren tone to a Yelp pattern (a fast rise and fall tone). Pressing the MAN button a second time returns it back to Wail.
- Activating the HORN RING input will change the siren tone to Yelp. Activating the HORN RING input again to return to a Wail tone.
- Activating the AUX ENABLE input has no effect.

**T2 (Tone #2)** - When the rotary knob is in the T2 position, a fast, rise and fall tone (YELP) is produced.

### With the Rotary Switch in this Position:

- Pressing the MAN button will produce the Piercer™ tone. Pressing the MAN switch a second time returns it back to Yelp.
- Activating the HORN RING input will produce the Airhorn tone until the HORN RING input is released.
- Activating the AUX ENABLE input has no effect.

**T3 (Tone #3)** - When the rotary knob is in the T3 position, an extremely fast, rise and fall tone is produced.

### With the Rotary Switch in this Position:

- Pressing the MAN button will result in the AIRHORN tone until the MAN button is released.
- Pressing the HORN RING input will result in the AIRHORN tone until the HORN RING input is released.
- Activating the AUX ENABLE will have no effect.

	<u>12-Volt Models</u>	<u>24-Volt Models</u>
INPUT VOLTAGE . . . . .	12 VDC ±20%	24 VDC ±20%
INPUT CURRENT . . . . .	16 AMPS (TYP.)	8 AMPS (TYP.)
INPUT FUSE . . . . .	20 AMPS	10 AMPS
SPEAKER IMPEDANCE . . . . .	11 OHMS MIN.	11OHMS MIN.
OPERATING TEMPERATURE . . . . .	-30° C. TO +80° C.	-30° C. TO +80° C.
STORAGE TEMPERATURE . . . . .	-40° C. TO +70° C.	-40° C. TO +70° C.
HUMIDITY . . . . .	99% (Non-Condensing)	99% (Non-Condensing)

ACTIVATION OF THIS SIREN MAY DAMAGE UNPROTECTED EARS!



**Wear Protection!**

CAUTION

Loud siren noise can cause hearing damage and/or loss. Refer to OSHA Section 1910.95 prior to putting ANY siren into service!

## Scan-Lock™ Programing Procedures

With Scan-Lock the tonal operation of the siren can be customized to fit the users needs. A momentary switch, accessed through a small hole on the back of the siren, is used to change the default siren tones as outlined below. A non-conductive tool (such as the tip of a pen) should be used to actuate this switch.

**To change the primary tone for rotary switch positions T1, T2, and T3:** Put the rotary switch in the position that you wish to change. Press and release the Scan-Lock switch. Each time the Scan-Lock switch is pressed and released, the next available tone will be broadcast (see "Tone List For Rotary Switch Positions T1, T2 & T3"). When the desired tone is generated, it will automatically be saved for that rotary switch position.

**To change the override tone for rotary switch positions T1, T2, and T3:** Put the rotary switch in the position that you wish to change. Press and hold the MAN button on the front panel on the siren. Press and release the Scan-Lock™ switch. Each time the Scan-Lock™ switch is pressed and released, the next available tone will be broadcast (see "Override Tone List For Rotary Switch Positions T1, T2 & T3"). When the desired tone is present, it will automatically be saved as the override tone for that rotary switch position. Release the MAN button.

**To change one of the tones in the hands free cycle as described in the "Rotary Switch Operations" section of this**

**manual:** Put the rotary switch in the HF position. Using the MAN button on the front panel on the siren, advance to the tone that you wish to change. Press and release the Scan-Lock switch. Each time the Scan-Lock switch is pressed and released, the next available tone will be broadcast (see "Tone List For Hands-Free Operation"). When the desired tone is generated, it will automatically be saved for that Hands-free cycle position.

**To change the tone for rotary switch positions MAN1 or MAN2:** Put the rotary switch in the position that you wish to change. Press and hold the MAN button on the front panel on the siren. Press and release the Scan-Lock switch. Each time the Scan-Lock switch is pressed and released, the next available tone will be broadcast (see "Tone List For MAN1 & MAN2 Operation"). When the desired tone is generated, it will automatically be saved for that rotary switch position. Release the MAN button.

**To change the override tone for rotary switch position RAD:** Put the rotary switch in the RAD position. Press and hold the MAN button on the front panel on the siren. Press and release the Scan-Lock switch. Each time the Scan-Lock switch is pressed and released, the next available tone will be broadcast (see "Override Tone List For RADIO Rotary Switch Position"). When the desired tone is generated, it will automatically be saved for that rotary switch position. Release the MAN button.

**To Restore the Factory Default Configuration** - Place the rotary switch into a Stand-by position (MAN1, MAN2, HF) and turn the unit OFF. While holding the Scan-Lock switch down, turn the unit ON. The factory default configuration is now restored.

### Tone List For Rotary Switch Positions T1, T2 & T3:

TONE OFF	PULSED AIRHORN
WAIL*	AIRHORN HI/LOW
YELP*	WOOP
PIERCER™	WARBLE
Y-249*	B -WAIL
HI/LOW	B - YELP
SIMULATED MECHANICAL	B - HILO

\* WAIL, YELP & Y-249 are California Title-13 Compliant Siren Tones.

### Override Tone List For Rotary Switch Positions T1, T2 & T3:

TONE OFF	AIRHORN HI/LOW
WAIL	WOOP
YELP	WARBLE
PIERCER	AIRHORN
Y-249	LOW FREQ. AIRHORN
HI/LOW	B -WAIL
SIMULATED MECHANICAL	B - YELP
PULSED AIRHORN	B - HILO

### Tone List For Hands Free Operation:

WAIL	AIRHORN HI/LOW
YELP	WOOP
PIERCER™	WARBLE
Y-249	B -WAIL
HI/LOW	B - YELP
SIMULATED MECHANICAL	B - HILO
PULSED AIRHORN	

### Tone List For MAN1 & MAN2 Operation:

TONE OFF
MANUAL SIMULATED MECHANICAL COAST-TO-STOP
MANUAL SIMULATED MECHANICAL STOP
MANUAL WAIL COAST-TO-STOP
MANUAL WAIL STOP
AIRHORN
LOW FREQ. AIRHORN

### Override Tone List For Rotary Switch Position Radio:

TONE OFF
AIRHORN COMMAND CODE
AIRHORN LOW COMMAND CODE