

WHELEN[®]

ENGINEERING COMPANY INC.

51 Winthrop Road
Chester, Connecticut 06412-0684
Phone: (860) 526-9504
Fax: (860) 526-4078
Internet: www.whelen.com
Sales e-mail: autosale@whelen.com
Canadian Sales e-mail: canadiansales@whelen.com
Customer Service e-mail: custserv@whelen.com

Configuration Guide: 6-button WeCan[®] Control Head with Slide Switch for Liberty[™] II, Freedom[®] IV and Legacy[®] Lightbars

Safety First

This document provides all the necessary information to allow your Whelen product to be properly and safely installed. Before beginning the installation and/or operation of your new product, the installation technician and operator must read this manual completely. Important information is contained herein that could prevent serious injury or damage.

- Proper installation of this product requires the installer to have a good understanding of automotive electronics, systems and procedures.
- Whelen Engineering requires the use of waterproof butt splices and/or connectors if that connector could be exposed to moisture.
- Failure to use specified installation parts and/or hardware will void the product warranty.
- If mounting this product requires drilling holes, the installer **MUST** be sure that no vehicle components or other vital parts could be damaged by the drilling process. Check both sides of the mounting surface before drilling begins. Also de-burr the holes and remove any metal shards or remnants. Install grommets into all wire passage holes.
- If this manual states that this product may be mounted with suction cups, magnets, tape or Velcro[®], clean the mounting surface with a 50/50 mix of isopropyl alcohol and water and dry thoroughly.
- Do not install this product or route any wires in the deployment area of your air bag. Equipment mounted or located in the air bag deployment area will damage or reduce the effectiveness of the air bag, or become a projectile that could cause serious personal injury or death. Refer to your vehicle owner's manual for the air bag deployment area. The User/Installer assumes full responsibility to determine proper mounting location, based on providing ultimate safety to all passengers inside the vehicle.
- For this product to operate at optimum efficiency, a good electrical connection to chassis ground must be made. The recommended procedure requires the product ground wire to be connected directly to the **NEGATIVE (-)** battery post (this does not include products that use cigar power cords).
- If this product uses a remote device for activation or control, make sure that this device is located in an area that allows both the vehicle and the device to be operated safely in any driving condition.
- It is recommended that these instructions be stored in a safe place and referred to when performing maintenance and/or reinstallation of this product.
- **FAILURE TO FOLLOW THESE SAFETY PRECAUTIONS AND INSTRUCTIONS COULD RESULT IN DAMAGE TO THE PRODUCT OR VEHICLE AND/OR SERIOUS INJURY TO YOU AND YOUR PASSENGERS!**

NOTE: This control head can either be used as a hand held unit or be mounted into a vehicle.

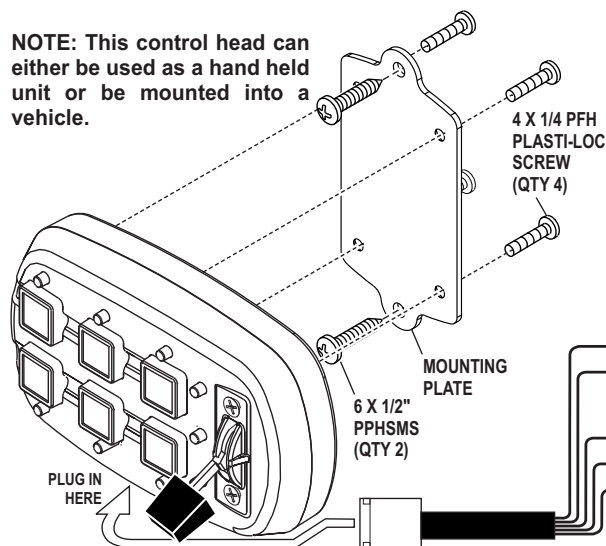

Installation:

1. Secure the mounting plate to the control head using the supplied 4 X 1/4 PFH Plasti-Loc screws.
2. Secure the controller to the mounting surface using the supplied 6 X 1/2" PPHSMS.
3. Extend the wires and connect as described below.

NOTE: Dip switches are located on the back of the unit.

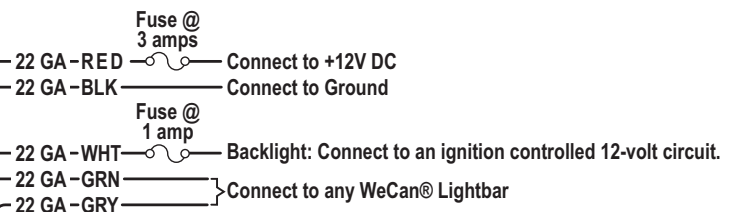

WARNING! All customer supplied wires that connect to the positive terminal of the battery must be sized to supply at least 125% of the maximum operating current and FUSED at the battery to carry the load. DO NOT USE CIRCUIT BREAKERS WITH THIS PRODUCT!

For warranty information regarding this product, visit www.whelen.com/warranty

Dip Switch Configuration #1

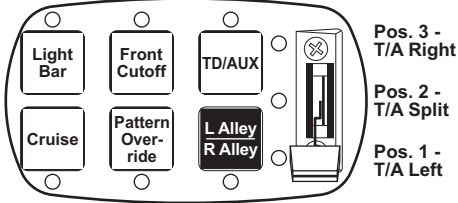
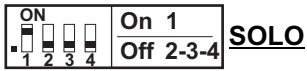

Dip Switch Configuration #2

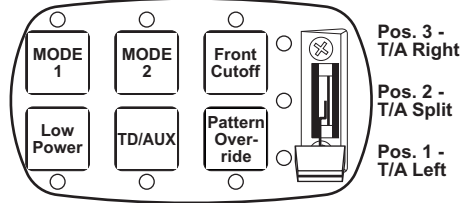
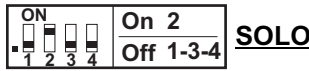

Dip Switch Configuration #3

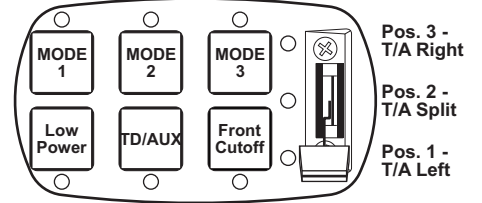
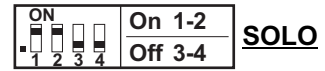

Dip Switch Configuration #4

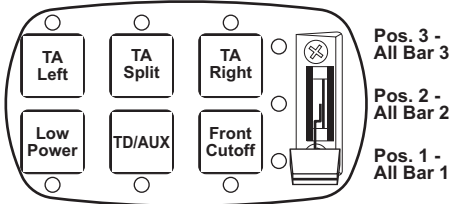
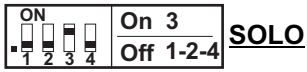

Dip Switch Configuration #5

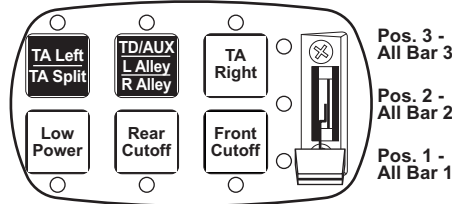
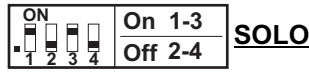

Dip Switch Configuration #6

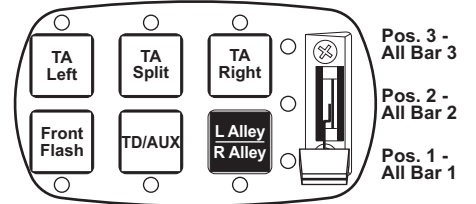
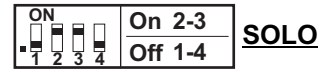

Dip Switch Configuration #7

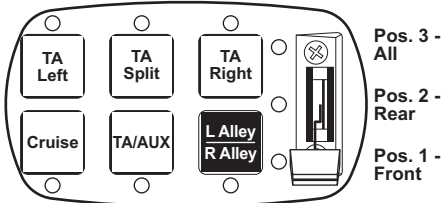
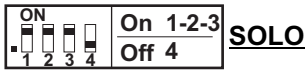

Dip Switch Configuration #8

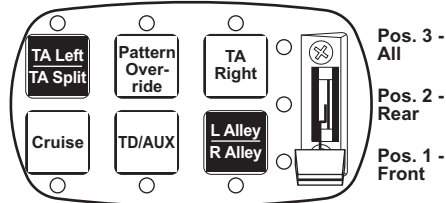
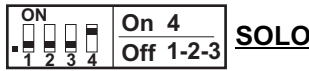

Dip Switch Configuration #9

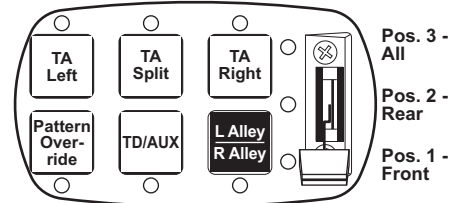
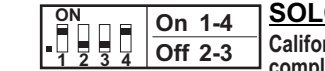

Dip Switch Configuration #10

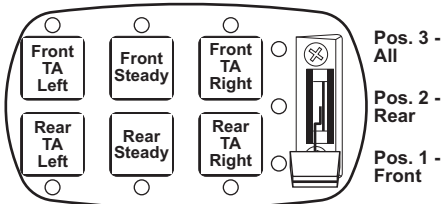
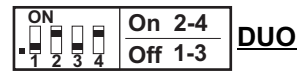

Dip Switch Configuration #11

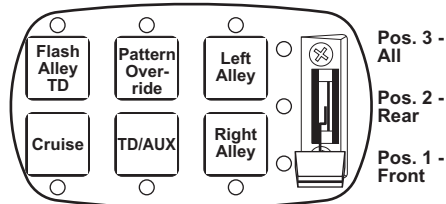
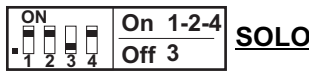

Dip Switch Configuration #12

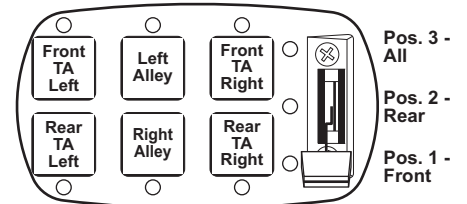
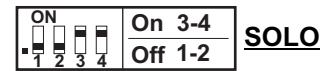

Dip Switch Configuration #13

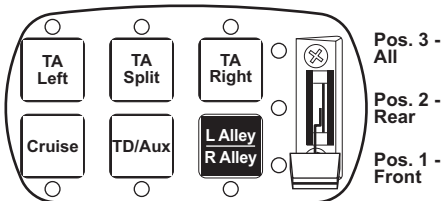
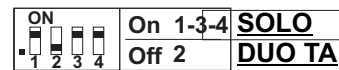

Dip Switch Configuration #14

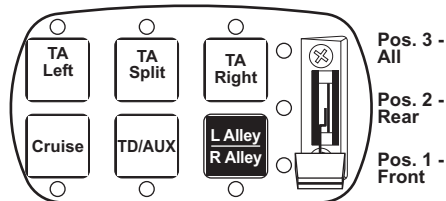
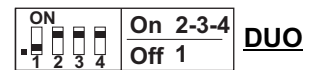

Dip Switch Configuration #15

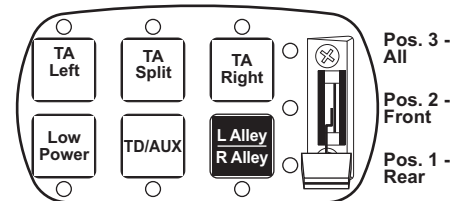
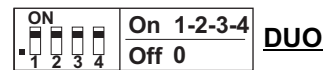

TD/AUX = Takedown / Auxiliary Take-Downs or Worklights

Some configurations will allow specific buttons to activate alternate functions with each press of that button. In the artwork shown, these buttons are represented with white letters on a black background. In these cases, the functions to be activated are shown in sequential order and are separated with a horizontal line.