

WHELEN[®]

ENGINEERING COMPANY INC.

51 Winthrop Road
Chester, Connecticut 06412-0684
Phone: (860) 526-9504
Fax: (860) 526-4078
Internet: www.whelen.com
Sales e-mail: autosale@whelen.com
Canadian Sales e-mail: canadiansales@whelen.com
Customer Service e-mail: custserv@whelen.com

Installation Guide:
Model 295SHA1 Siren/Howler
Control Center

DANGER! Sirens produce extremely loud emergency warning tones! Exposure to these tones without proper and adequate hearing protection, could cause ear damage and/or hearing loss! The Occupational Safety & Health Administration (www.osha.gov) provides information necessary to determine safe exposure times in Occupational Noise Exposure Section 1910.95. Until you have determined the safe exposure times for your specific application, operators and anyone else in the immediate vicinity should be required to wear an approved hearing protection device. **FAILURE TO FOLLOW THIS RECOMMENDATION COULD CAUSE HEARING LOSS!**

Warnings to Installers

Whelen's emergency vehicle warning devices must be properly mounted and wired in order to be effective and safe. Read and follow all of Whelen's written instructions when installing or using this device. Emergency vehicles are often operated under high speed stressful conditions which must be accounted for when installing all emergency warning devices. Controls should be placed within convenient reach of the operator so that they can operate the system without taking their eyes off the roadway. Emergency warning devices can require high electrical voltages and/or currents. Properly protect and use caution around live electrical connections. Grounding or shorting of electrical connections can cause high current arcing, which can cause personal injury and/or vehicle damage, including fire. Many electronic devices used in emergency vehicles can create or be affected by electromagnetic interference. Therefore, after installation of any electronic device it is necessary to test all electronic equipment simultaneously to insure that they operate free of interference from other components within the vehicle. Never power emergency warning equipment from the same circuit or share the same grounding circuit with radio communication equipment. All devices should be mounted in accordance with the manufacturer's instructions and securely fastened to vehicle elements of sufficient strength to withstand the forces applied to the device. Driver and/or passenger air bags (SRS) will affect the way equipment should be mounted. This device should be mounted by permanent installation and within the zones specified by the vehicle manufacturer, if any. Any device mounted in the deployment area of an air bag will damage or reduce the effectiveness of the air bag and may damage or dislodge the device. Installer must be sure that this device, its mounting hardware and electrical supply wiring does not interfere with the air bag or the SRS wiring or sensors. Mounting the unit inside the vehicle by a method other than permanent installation is not recommended as unit may become dislodged during swerving; sudden braking or collision. Failure to follow instructions can result in personal injury. Whelen assumes no liability for any loss resulting from the use of this warning device. **PROPER INSTALLATION COMBINED WITH OPERATOR TRAINING IN THE PROPER USE OF EMERGENCY WARNING DEVICES IS ESSENTIAL TO INSURE THE SAFETY OF EMERGENCY PERSONNEL AND THE PUBLIC.**

Warnings to Users

Whelen's emergency vehicle warning devices are intended to alert other operators and pedestrians to the presence and operation of emergency vehicles and personnel. However, the use of this or any other Whelen emergency warning device does not guarantee that you will have the right-of-way or that other drivers and pedestrians will properly heed an emergency warning signal. Never assume you have the right-of-way. It is your responsibility to proceed safely before entering an intersection, driving against traffic, responding at a high rate of speed, or walking on or around traffic lanes. Emergency vehicle warning devices should be tested on a daily basis to ensure that they operate properly. When in actual use, the operator must ensure that both visual and audible warnings are not blocked by vehicle components (i.e.: open trunks or compartment doors), people, vehicles, or other obstructions. It is the user's responsibility to understand and obey all laws regarding emergency warning devices. The user should be familiar with all applicable laws and regulations prior to the use of any emergency vehicle warning device. Whelen's audible warning devices are designed to project sound in a forward direction away from the vehicle occupants. However, because sustained periodic exposure to loud sounds can cause hearing loss, all audible warning devices should be installed and operated in accordance with the standards established by the National Fire Protection Association.

Safety First

This document provides all the necessary information to allow your Whelen product to be properly and safely installed. Before beginning the installation and/or operation of your new product, the installation technician and operator must read this manual completely. Important information is contained herein that could prevent serious injury or damage.

- Proper installation of this product requires the installer to have a good understanding of automotive electronics, systems and procedures.
- Whelen Engineering requires the use of waterproof butt splices and/or connectors if that connector could be exposed to moisture.
- Failure to use specified installation parts and/or hardware will void the product warranty.
- If mounting this product requires drilling holes, the installer **MUST** be sure that no vehicle components or other vital parts could be damaged by the drilling process. Check both sides of the mounting surface before drilling begins. Also de-burr the holes and remove any metal shards or remnants. Install grommets into all wire passage holes.
- If this manual states that this product may be mounted with suction cups, magnets, tape or Velcro[®], clean the mounting surface with a 50/50 mix of isopropyl alcohol and water and dry thoroughly.
- Do not install this product or route any wires in the deployment area of your air bag. Equipment mounted or located in the air bag deployment area will damage or reduce the effectiveness of the air bag, or become a projectile that could cause serious personal injury or death. Refer to your vehicle owner's manual for the air bag deployment area. The User/Installer assumes full responsibility to determine proper mounting location, based on providing ultimate safety to all passengers inside the vehicle.
- For this product to operate at optimum efficiency, a good electrical connection to chassis ground must be made. The recommended procedure requires the product ground wire to be connected directly to the NEGATIVE (-) battery post (this does not include products that use cigar power cords).
- If this product uses a remote device for activation or control, make sure that this device is located in an area that allows both the vehicle and the device to be operated safely in any driving condition.
- It is recommended that these instructions be stored in a safe place and referred to when performing maintenance and/or reinstallation of this product.
- **FAILURE TO FOLLOW THESE SAFETY PRECAUTIONS AND INSTRUCTIONS COULD RESULT IN DAMAGE TO THE PRODUCT OR VEHICLE AND/OR SERIOUS INJURY TO YOU AND YOUR PASSENGERS!**

**ACTIVATION OF THIS
SIREN MAY DAMAGE
UNPROTECTED EARS!**



CAUTION
Loud siren noise can cause hearing damage and/or loss. Refer to OSHA Section 1910.95 prior to putting ANY siren into service!

The 295SHA1 Siren/Howler Control Center offers a unique collection of features designed to allow the user to customize operation to suit their individual needs. Features include:

Siren:

- Non-destructive short circuit protection.
- Under/over voltage protection.
- LED fault indicators for speakers and input voltage diagnostics.
- Title 13 compliant tone set up.
- 17 programmable tones.
- Horn-ring transfer relay built in.
- Two independent amplifiers drive one 100 watt speaker and one Howler speaker.
- 3 programmable low frequency tone styles.

- 8 Programmable Howler run times.
- Siren “in use” icon driver output.
- Siren disable (Park kill) control input.
- Includes Radio Repeat and PA.

Lighting control:

- 11 Programmable lighting control Switches (one 3 position slide switch and 8 momentary switches).
- Three 20 Amp relay controlled outputs with built in fuses.
- Eight 10 Amp relay controlled outputs with built in fuses (two of them include a choice of independent inputs or the standard power bus switching).
- Two wire TrafficAdvisor™ control.

- Programming can not be activated by a user in the cab.
- All switches can be programmed to activate/deactivate any combination of relay outputs.
- All switches can be programmed to activate any of the 8 momentary switches.
- Momentary switches can be programmed to be activated as either a *push-on / push-off*, *momentary*, *flashing*, *timed output*, or *TA control*.
- All switches can be programmed to activate the siren into HF mode.
- Copy one units configuration to another unit, “CLONING”.
- Easy reset to factory default settings.
- Change the “Shutdown Delay” time.
- Program backlight intensity of control head.

IMPORTANT! READ THESE WARNINGS BEFORE CONTINUING!

The Howler™ portion of this siren is a supplemental siren and was designed for use in high-risk areas such as an intersection. It is not intended to be, nor should be operated as, a replacement or alternative to the vehicle’s primary siren.

The low-frequency tones of the Howler demonstrate significantly different audio characteristics as compared to those of a traditional higher-frequency siren. While the low-frequency tones are better able to penetrate other vehicles, thus alerting drivers to the presence of the responding emergency vehicle, these tones may also penetrate into the responding vehicle itself. This could potentially expose the operator to increased noise levels.

To help eliminate overexposure, the Howler siren has been designed with a built-in timing circuit. The Occupational Safety & Health Administration (OSHA) (www.osha.gov) provides information necessary to determine safe exposure times in Noise and Hearing Conservation, Section 1910.95 (Occupational Noise Exposure). Until you have determined the safe exposure times for your specific application, this siren should be configured for the minimum operating time and operators should be required to use an approved hearing protection device. **FAILURE TO FOLLOW THIS RECOMMENDATION COULD CAUSE HEARING LOSS!**

Installation 295SHA1 Module:

1. Locate a suitable mounting location such as a dry, cool compartment and position the unit where it will be mounted. Make sure that the mounting area allows sufficient ventilation. Using an awl or similar tool, scribe the mounting surface where the mounting holes are to be drilled.
2. Remove the unit and use a 9/64 drill bit to drill a hole in each of the areas scribed in step 2.
3. Return the unit to its mounting location and use the provided #10 x 3/4” sheet metal screws and #10 internal tooth lock washers to secure the unit to the mounting surface. **IMPORTANT:** The case must be either mounted on, or grounded to the vehicle chassis.

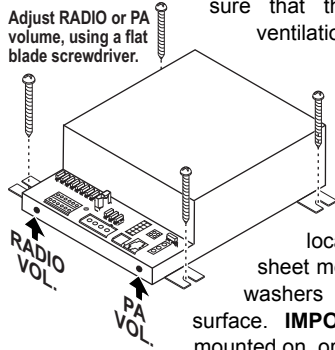

3. Using hardware provided (#10 x 3/4” sheet metal screw and #10 internal tooth lock washer) secure bail strap to mounting location.

NOTE: There are 3 sets of holes on the bail strap for positioning the control head at 3 different heights.

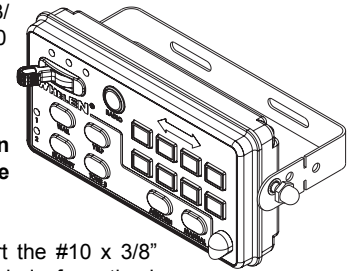

4. With the bail strap in place, insert the #10 x 3/8” hex head bolt into the assembly hole from the inner side of the bail strap as shown.
5. Place the #10 internal-tooth lock washer and the acorn nut on the protruding bolt on the outer side of the bail strap. Loosely secure the acorn nut to the hex head bolt.

Slide the control head onto the bolt heads. Once it is in position and the control head has fully engaged the bolt heads, tighten the acorn nuts until the unit is firmly secured.

Control Head:

There are two control head mounting brackets to choose from. One allows the control head to be mounted into your vehicle’s console (if so equipped). The other allows the control head to be mounted directly onto the dash or other surface through the use of a bail strap mounting bracket. **Regardless of the style selected, be sure to observe the air bag warning on the cover of this manual.**

Bail Strap Mount:

1. Position the bail strap in the selected mounting location. Using an awl or other suitable tool, scribe the surface where the mounting holes are to be drilled.
2. Drill the mounting holes in the areas scribed in step 1. The size of the drill bit should be determined by the size of the mounting hardware (#10 sheet metal screw) and thickness of the mounting surface.

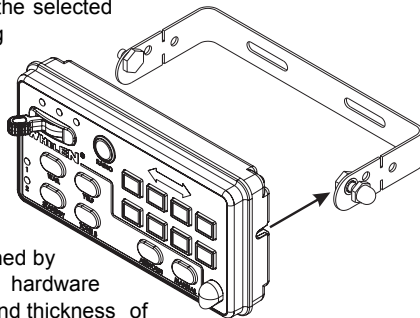

A third pair of mounting holes are provided which allows the control head to be located much closer to the bail strap. If this closer location is used, the tips of the bail bracket may be broken off at the notches.

Control Head Cable:

Route the control head cable from the amp/relay module to the designated mounting location. Plug the cable securely into the rear of the control head. Be sure to route the cable through either of the two recessed pathways (shown here). This will prevent the cable from being disconnected or pinched by the control head.

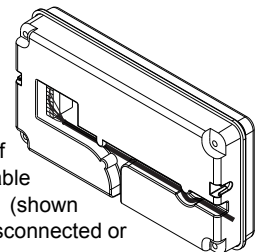

Havis Console Mount:

The Havis Console mounting kit includes all the necessary hardware needed to secure the control head to the mounting bracket for installation on a Havis Console. The control head mounts onto the console mounting bracket the same way the control head mounts onto the bail bracket as outlined previously except for the addition of a flat washer that must be inserted between the control head and the bracket. Please refer to the manual included with your console for specific information on securing the control head/mounting bracket assembly onto the console.

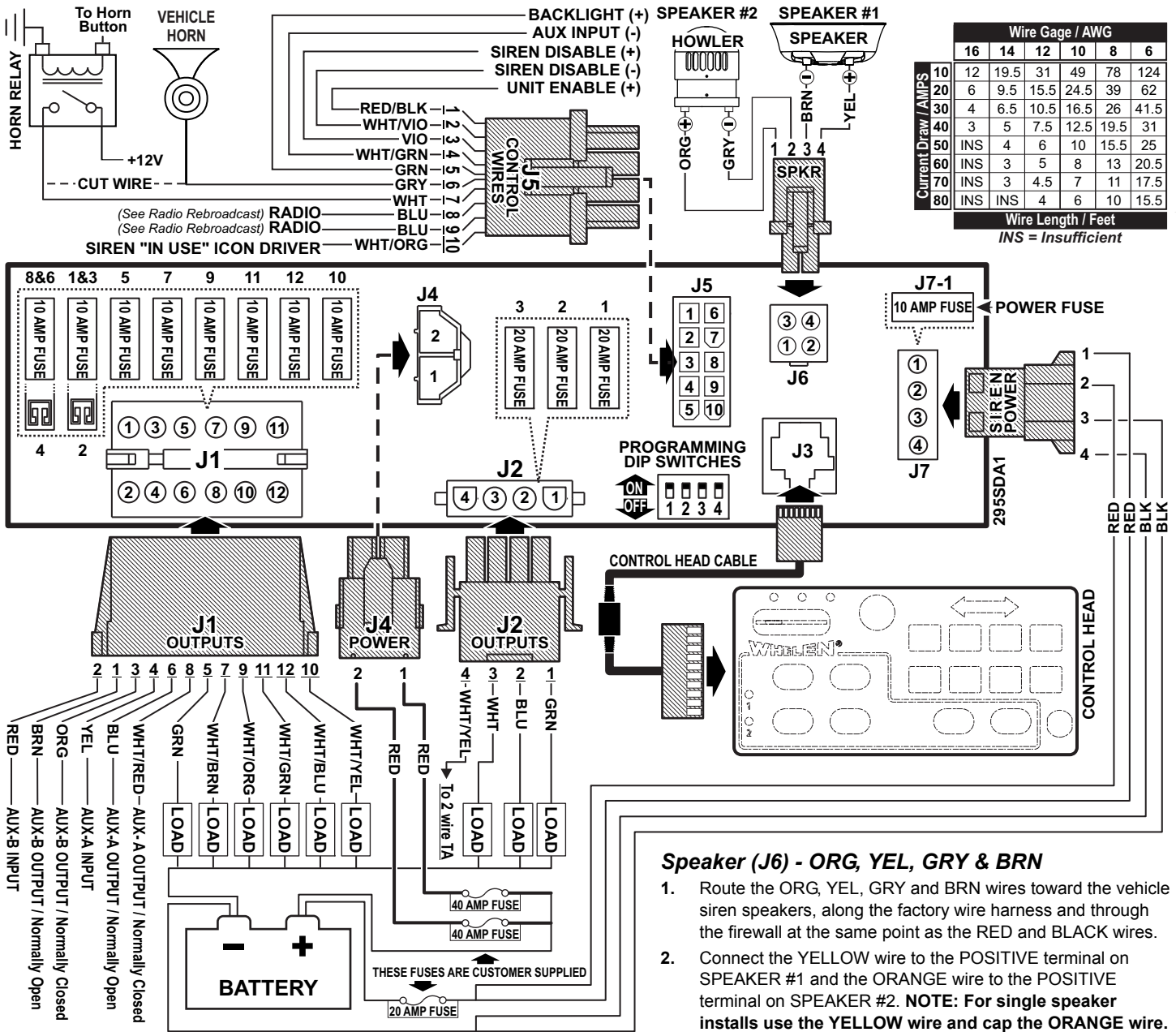

Wiring:

WARNING: All customer supplied wires that connect to the positive terminal of the battery must be sized to supply at least 125% of the maximum operating current and FUSED at the battery to carry that load. **DO NOT USE CIRCUIT BREAKERS WITH THIS PRODUCT!**

Siren Input (J7) - RED: Power - BLACK: Ground

1. Splice the 2 RED (Power) wires together and extend this single RED wire toward the vehicle battery. Splice the 2 BLACK (Ground) wires together and extend this single BLACK wire toward the vehicle battery. You may have to drill a hole in the firewall to pass the RED and BLACK wires through. Insert a grommet to protect the wires.
2. Route the RED and BLACK wires along the factory harness towards the battery and install a fuse block (user supplied) on the end of the RED wire. **Remove fuse from fuse block before connecting any wires to battery.**
3. Connect fuse block wire to POSITIVE terminal on battery. There must not be more than 2 feet of wire between fuse block and battery. The wire between the fuse and battery is "unprotected", do not allow it to chafe and short to ground. Connect the BLACK wire to the factory chassis ground.

Horn Relay (J5) - WHITE & GREY

1. Route WHITE and GREY wires along factory wire harness and through the firewall at the same point as the RED and BLACK wires.
2. Route WHITE and GREY wires to vehicle's horn relay. If possible, follow the factory wire harness to this relay.
3. Cut the wire that connects the vehicle horn to the horn relay.
4. Connect the WHITE wire to the wire coming from the horn relay and the GREY wire to the wire going to the horn.

Radio Rebroadcast (J5) (optional) - Two BLUE wires

The two BLUE wires are used to connect your two-way radio's external speaker for radio rebroadcast (optional connection).

Note: If your remote speaker is amplified (speaker has a power amp circuit), radio rebroadcast will not work and should not be used.

1. Locate the 2 wires that connect the external speaker to the 2-way radio, cut one and splice one of the BLUE wires into this circuit.
2. Cut the remaining speaker wire and splice the other BLUE wire into this circuit.

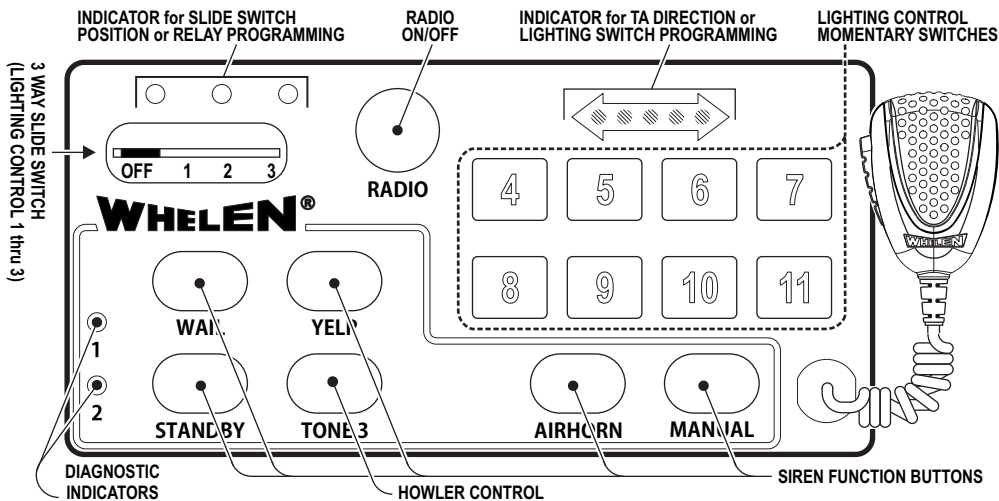

- Activating the RADIO, WAIL, or STANDBY button will deactivate the YELP button and produce their corresponding function.
- Activating the HORN RING input or MAN button will change the siren tone to PIERCER. Activating the HORN RING input or MAN button a second time returns it back to YELP tones.
- Activating the SIREN DISABLE input will deactivate the YELP button.

TONE3:

Important! The Howler is designed to operate as a supplement to the primary siren. The Howler will not operate unless the primary siren is actively generating a siren tone.

Factory Default Operations:

The operations described in this section are the *factory default* settings that the unit is shipped with. To change the settings, refer to **Programming the 295SHA1** for information on how to customize the operation of the siren/lighting control center.

Siren Operations

RADIO - Radio Rebroadcast:

When this button is pressed, any signal that is received by the vehicle's two-way radio will be simultaneously broadcast over the vehicle's loudspeaker (the unit must be connected to the two-way radio as outlined in this manual). Pressing the RADIO button again will deactivate it.

With the RADIO button activated:

- Activating the AIRHORN button will produce an AIRHORN tone.
- Activating the WAIL, YELP, STANDBY, or MAN button will deactivate the RADIO button and produce their corresponding function.
- Activating the HORN RING input will produce the cars horn until the HORN RING switch is released.
- Activating the SIREN DISABLE input has no effect.

WAIL –Wail tone:

When this button is pressed, the siren will produce a Wail tone. Pressing the WAIL button again will deactivate it.

With the WAIL button activated:

- Activating the AIRHORN button will produce an AIRHORN tone until released.
- Activating the RADIO, YELP or STANDBY button will deactivate the WAIL button and produce their corresponding function.
- Activating the HORN RING input or MAN button will change the siren tone to a Yelp tone. Activating the HORN RING input or MAN button a second time returns it back to WAIL tones.
- Activating the SIREN DISABLE input will deactivate the WAIL button.

YELP – Yelp tone:

When this button is pressed, the siren will produce a yelp tone. Pressing the YELP button again will deactivate the button.

With the yelp button activated:

- Activating the AIRHORN button will produce an AIRHORN tone until released.

To activate the Howler™ siren, press the TONE3 Switch while the primary siren is generating a tone. The Howler will match the primary siren according to the Tone Style configuration settings. Once activated, the Howler will produce tones for a period of time determined by the Tone Duration configuration settings. When that duration has been reached, the Howler will automatically stop.

To cancel the Howler siren before the Tone Duration time period is completed, press the TONE3 switch a second time.

STANDBY – Hands Free:

When you press STANDBY the siren functions are placed in a stand-by mode. Siren tones are activated by a single “tap” on the MANUAL button or the vehicle's steering wheel horn ring (if the vehicle's horn has been wired to the HORN RING input). The first tap produces Wail tone. A second tap produces Yelp tones. A third tap produces a Piercer™ tone. The next tap returns the siren to the Wail tones and the cycle repeats itself. Two quick successive taps stop the siren.

With the STANDBY button activated:

- Activating the AIRHORN button will produce an AIRHORN tone until released.
- Activating the RADIO, WAIL or YELP button will deactivate the STANDBY button and produce their corresponding function.
- Activating the HORN RING input or MAN button will produce the hands free cycle as described above.
- Activating the SIREN DISABLE input will deactivate the STANDBY button.

MANUAL – Manual Wail:

When no other siren buttons are activated, pressing the Manual button generates Wail tones that rise in pitch to a pre-set level. This tone is generated for as long as the Manual button is pressed. When the button is released the tone coasts down in frequency to a pre-set level and stops.

AIRHORN – Airhorn tone:

- Activating the AIRHORN button will always produce an AIRHORN tone until released.

MICROPHONE – Public address:

- Activating the Push To Talk switch on the microphone will put the siren in public address operation and will momentarily shut down any other siren function until the switch is released.

Lighting Control Operations:

Lighting Control Switches: The lighting control switches include the slide switch and the 8 momentary switches. The slide switch having one off position and three active positions combined with the 8 momentary switches makes a total of 11 lighting control switch positions. For each of the 11 switches there are corresponding relay controlled outputs on the connectors of J1 and J2 (see wiring diagram). The following list describes the Factory Default switch activated outputs.

Slide Switch Positions:

- 0 = output OFF (Stops HF cycle / Section 5 - Note "B")
- 1 = output J2 pin 1 (GRN) (Stops HF cycle / Section 5 - Note "B")
- 2 = outputs J2 pin 1 (GRN) & pin 2 (BLU) (Stops HF / Section 5 - Note "B")
- 3 = outputs J2 pin 1 (GRN), pin 2 (BLU), pin 3 (WHT), and start the sirens STANDBY hands free cycle.

Push-Button Switches	Wire	Switch-Type
4	Outputs J1 PIN 10 (WHT/YEL)	Push on-Push off
5	Outputs J1 PIN 12 WHT/BLU)	Push on-Push off
6	Outputs J1 PIN 11 (WHT/GRN)	Push on-Push off
7	Outputs J1 PIN 9 (WHT/ORG)	Push on-Push off
8	Outputs J1 PIN 7 (WHT/BRN)	Push on-Push off
9	Outputs J1 PIN 5 (GRN)	Push on-Push off
10	Outputs J1 PIN 1 (BRN)	Push on-Push off
11	Outputs J1 PIN 6 (BLU)	Momentary

Traffic Advisor Control

There are two programmable "Switch Types" associated with Traffic Advisor control, "Traffic Advisor Pattern Control" and "Traffic Advisor Flash Control".

When a switch's "Switch Type" has been programmed as "Traffic Advisor Pattern Control", this switch now takes control of designated Traffic Advisor output J2 pin 4 (white yellow) and the associated relay output of the programmed switch. These two wires connect to the traffic advisor.

The first press of this switch will produce a Left sweep on the Traffic Advisor, and will turn off a "Traffic Advisor Flash Control" switch if one is active.

A second press will produce a right arrow.

A third press will produce a split arrow.

The next press returns the unit to Left arrow and the cycle repeats itself. Holding the switch down for 2 seconds will shut the arrow off.

NOTE: Only one switch can be programmed as a "Traffic Advisor Pattern Control" switch, if more than one switch is programmed, unpredictable results will occur.

When a switch's "Switch Type" has been programmed as "Traffic Advisor Flash Control":

Pressing this switch will produce a flash pattern on the Traffic Advisor indicator, will turn off a "Traffic Advisor Pattern Control" switch if one is active, and the relay output programmed for the "Traffic Advisor Flash Control" switch will turn on.

Pressing this switch again will shut the arrow off.

NOTE: Only one switch can be designated as a "Traffic Advisor Flash Control" switch, if more than one switch is programmed, unpredictable results will occur.

Diagnostic Indicators:

While the siren is under normal use the diagnostic indicators are used to indicate fault conditions within your siren system. The following table lists the type of fault and the indicators response. If the indicator is on steady while a tone is in use, this indicates that there is no fault with the associated speaker output.

Under voltage: LED #2 will be in DoubleFlash mode and siren tones will not operate.

Over voltage: LED #1 will be in DoubleFlash mode and siren tones will not operate.

Speaker # 1 short circuit: LED #1 will be in SingleFlash mode and siren tones will not operate on speaker 1.

Speaker # 2 short circuit: LED #2 will be in SingleFlash mode and siren tones will not operate on speaker 2.

Speaker #1 open circuit: LED #1 will be off all siren tones will continue to operate.

Speaker #2 open circuit: LED #2 will be off all siren tones will continue to operate.

DoubleFlash: 2 quick flashes followed by a longer pause.

SingleFlash: LED will be on and off an equal amount of time.

Terminal Operation

Terminal Specifications

NOTE: It is important that any components connected to these terminals do not exceed the maximum current rating for that terminal.

Warning! Total power distribution current is not to exceed 80 AMPS

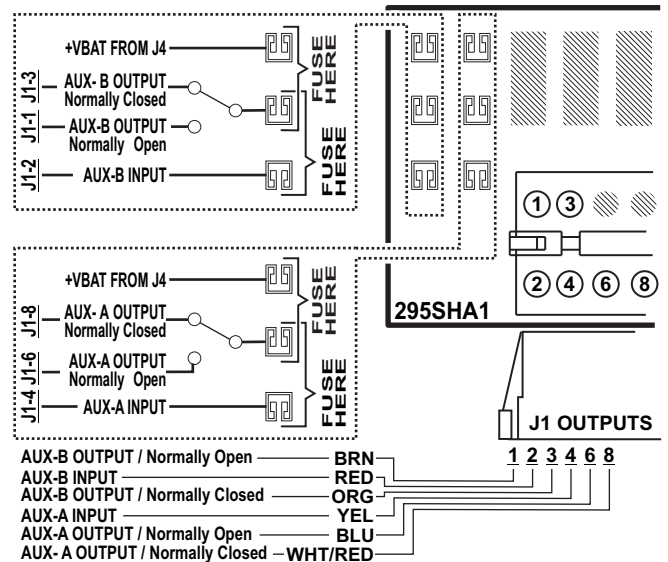

Outlet	Max. Load	
J2-1	20 Amps	J1-10 10 Amps
J2-2	20 Amps	J1-11 10 Amps
J2-3	20 Amps	J1-12 10 Amps
J1-5	10 Amps	J1-1 & J1-3 or J1-2 10 Amps
J1-7	10 Amps	(Outlets can not be activated simultaneously)
J1-9	10 Amps	J1-8 & J1-6 or J1-4 10 Amps
		(Outlets can not be activated simultaneously)

Programming the 295SHA1:

WARNING: Never try to program the unit while it is wired to the vehicle. The unit must be removed from the vehicle before programming. For programming, connect positive (+) 12 volts and ground to J7, and pin 1 of J5 to (+) 12 volts only.

The **295SHA1** has the ability to program both the siren switches and the lighting control switches via the keypad of the control head.

Switches include a slide switch, 8 lighting control momentary switches, and 7 momentary siren control switches. The slide switch has one off position and three active positions combined with the 8 momentary switches, making a total of 11 lighting control switches. For each of the 11 switches there are 11 corresponding relay outputs.

The **295SHA1** has the capability of customizing how the lighting control switches operate, and how they control the relay outputs as well as siren enable. Any of the 8 lighting control momentary switches can be configured to operate in one of six switch types: *push on push off*, *momentary*, *flashing*, *timed output*, *TA pattern control* or *TA flash control*.

Any of the 11 switches can be programmed to activate any combination of relay outputs. Any of the 11 switches can be configured to remotely activate or deactivate any of the 8 lighting control momentary switches. Any of the 11 switches can be configured to activate the siren into the HF mode. One unit's programmed configuration can be copied to another unit, and factory defaults can be restored.

Any tone can be programmed into any active siren control location. *Title 13 Operation* (and a set of title 13 tones) can be programmed as well as *Ignition Shutdown Delay* and *Indicator* or *Backlight* intensity. The following sections describe programming.

Programming the lighting control operations:

Put the unit into "Lighting control programming mode" by placing DIP switch 1 into the **ON** position and DIP switch 4 in the **OFF** position (See wiring diagram). With the DIP switches in this position siren functions are disabled, leaving the lighting functions and lighting programming active.

(1) Momentary Switch: Programming Switch Type:

The 8 momentary switches can be configured to operate as one of six types. The six types are: *Push On Push Off*, *Momentary*, *Flashing Output (60 FPM)*, *Timed Output (10 seconds)*, *TA pattern control* or *TA flash*.
Factory Default: SW4 – SW10 = *push on-push off* SW11 = *Momentary*
(DIP SWITCH SETTING: SWITCH 1 ON / SWITCH 4 OFF)

To Configure a switch's "Switch Type":

1. Put the unit into "Switch Type" configuration Mode:

- Place the SLIDE SWITCH in the OFF position (all the way to the left) and turn all momentary switches off.
- Press and hold the RADIO switch.
- Press and release momentary switch 4.
- Release the RADIO switch.



To confirm entry into this configuration mode, LED 1 on the Arrow indicator will light up.

2. Select a switch to be configured:

- Press and release the momentary switch that you wish to configure.

The selected switch's light will turn on steady. The slide switch indicator lights will light up indicating the type of switch that is currently configured (table 2).

Table 2

①	②	③	Slide Switch Indicators
●	●	●	Push On Push Off
○	●	●	Momentary
●	○	●	Timed Output
○	○	●	Flashing Output
●	●	○	TA Pattern Control
○	●	○	TA Flash Control
●	○	○	= OFF ○ = ON

3. Choose a "Switch Type" for the selected switch:

- Press and release the AIRHORN switch to cycle through the switch type choices in table 2.
- Stop when the indicator lights match the desired switch type.

4. Store and activate the switch's "Switch Type":

- Press and release the RADIO switch.

All of the indicator lights will turn off and the data will be stored. This will put the unit back into lighting operating mode, and this change can be tested. To configure another switch start back at step 1.

(2) Relay Output Programming:

Any of the 11 lighting control switches can be configured to activate any combination of the 11 relay outputs.

DIP SWITCH SETTING: SWITCH 1 ON / SWITCH 4 OFF

To Configure a switch's relay outputs:

1. Put the unit into "Relay Output" configuration mode:

- Place the SLIDE SWITCH in the OFF position (all the way to the left) and turn all Momentary switches off.
- Press and hold the RADIO switch.
- Press and release momentary switch 5.
- Release the RADIO switch.

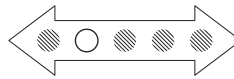

To confirm entry into this configuration mode, LED 2 on the Arrow indicator will light up.

2. Select a switch to be configured:

- Press and release the momentary switch that you wish to configure.

OR...

- Move the slide switch to the position that you wish to configure.
- Press and release the MANUAL switch.

All switch indicator lights whose corresponding relay output is already in the selected switch's configuration will turn on steady.

3. Add or delete relay outputs activated by the switch:

- Press and release one of the 8 momentary switches to add or delete its corresponding output. This switch's indicator light will turn on steady when its corresponding output is selected to be activated.

OR...

- Press and release the AIRHORN switch to cycle through the SLIDE SWITCH'S corresponding outputs. Stop when indicator lights equal the desired output pattern.

4. Store and activate the switch's relay output pattern:

- Place the SLIDE SWITCH in the OFF position.
- Press and release the RADIO switch.

All indicator lights will turn off and the data will be stored. This will put the unit back into lighting operating mode, and this change can be tested.

To configure another switch start back at step 1.

(3) Re-Setting Factory Defaults

(lighting and siren operation):

(DIP SWITCH SETTING: SWITCH 1 ON / SWITCH 4 OFF)

To restore the factory defaults:

- Place the SLIDE SWITCH in the OFF position (all the way to the left) and turn all Momentary switches off.
- Press and hold the RADIO switch.
- Press and release momentary switch 6.
- Release the RADIO switch.

To confirm that the factory defaults have been restored, LED 3 on the Arrow indicator will light up for two seconds.

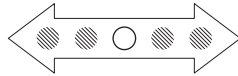

After the 2 seconds pass, all of the indicator lights will turn off and the factory defaults will be stored. This will put the unit back into lighting operating mode, and the lighting defaults can be tested.

NOTE: The siren defaults cannot be tested until the unit is out of programming mode (i.e. all dip switches ON)

(4) Activating the Siren:

Any of the 11 lighting control switches can be configured to activate the siren into the HF mode.

Factory Default: Slide Switch Position 3

To activate the siren from a lighting switch:

(DIP SWITCH SETTING: SWITCH 1 ON / SWITCH 4 OFF)

1. Put the unit into "Siren Activation" mode:

- Place the SLIDE SWITCH in the OFF position (all the way to the left) and turn all Momentary switches off.
- Press and hold the RADIO switch.
- Press and release momentary switch 7.
- Release the RADIO switch.

To confirm entry into this configuration mode, LED 4 on the Arrow indicator will light up.

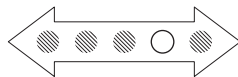

AND...

All switch indicator lights whose corresponding switch is already programmed to activate the Siren will turn on steady.

2. Add or Delete switches:

To select a momentary switch:

- Press and release one of the 8 momentary switches to add or delete it from activating the siren. The switches indicator light will turn on steady when its corresponding switch is selected.

OR...

To select a slide switch position:

- Move the slide switch to the position that you wish to activate the siren.
- Press and release the MANUAL switch, the slide switches indicator light will turn on steady when its switch position has been selected.

3. Store and activate the selected switch's:

- Place the SLIDE SWITCH in the OFF position.
- Press and release the RADIO switch.

All of the indicator lights will turn off and the data will be stored. This will put the unit back into lighting operating mode.

NOTE: This change cannot be tested until the unit is out of programming mode (i.e. all dip switches ON)

(5) Deactivating the Siren:

Any of the 11 lighting control switches can be configured to deactivate the siren out of HF mode.

Factory Default: Slide Switch Positions 1, 2

To deactivate the siren from a lighting switch:

(DIP SWITCH SETTING: SWITCH 1 ON / SWITCH 4 OFF)

1. Put the unit into "Siren Deactivation" mode:

- Place the SLIDE SWITCH in the OFF position (all the way to the left) and turn all Momentary switches off.
- Press and hold the RADIO switch.
- Press and release momentary switch 11.
- Release the RADIO switch.

To confirm entry into this configuration mode, LED 2 and 3 on the Arrow indicator will light up.

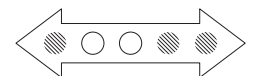

AND...

All switch indicator lights whose corresponding switch is already programmed to deactivate the Siren will turn on steady.

2. Add or Delete switches:

To select a momentary switch:

- Press and release one of the 8 momentary switches to add or delete it from deactivating the siren. The switches indicator light will turn on steady when its corresponding switch is selected.

OR...

To select a slide switch position:

- Move the slide switch to the position that you wish to deactivate the siren.
- Press and release the MANUAL switch, the slide switches indicator light will turn on steady when its switch position has been selected.

3. Store and activate the selected switch's:

- Place the SLIDE SWITCH in the OFF position.
- Press and release the RADIO switch.

All of the indicator lights will turn off and the data will be stored. This will put the unit back into lighting operating mode.

NOTE "A": This change cannot be tested until the unit is out of programming mode (i.e. all dip switches ON)

NOTE "B": When slide switch positions are used to deactivate the siren from HF mode, deactivation will only take place when the slide switch is moved out of a position that was programmed to activate the siren.

(6) Remote Activation of the 8 Momentary switches:

Any of the 11 lighting control switches can be configured to remotely activate any of the 8 momentary lighting control switches.

Factory Default: No momentary switches are remotely activated.

(DIP SWITCH SETTING: SWITCH 1 ON / SWITCH 4 OFF)

To activate Momentary Switches:

1. Put the unit into Momentary Switch Activation Mode:

- Place the SLIDE SWITCH in the OFF position and turn all momentary switches off.
- Press and hold the RADIO switch.
- Press and release momentary switch 8.
- Release the RADIO switch.

To confirm entry into this configuration mode, LED 5 on the Arrow indicator will light up.

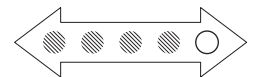

2. Select a switch to be configured:

To select a momentary switch:

- Press and release the momentary switch that you wish to configure.

OR...

To select a slide switch position:

- Move the slide switch to the position that you wish to configure.
- Press and release the MANUAL switch.

All switch indicator lights whose corresponding switch is already programmed to be activated by the selected Switch will turn on steady.

3. Add or delete momentary switches activated by the selected switch:

- Press and release one of the 8 momentary switches to add or delete it from the selected switch's configuration. The switch's indicator light will turn on steady when its corresponding switch is selected to be activated.

4. Store and activate the selected switch's configuration:

- Place the SLIDE SWITCH in the OFF position.
- Press and release the RADIO switch.

All of the indicator lights will turn off and the data will be stored. This will put the unit back into lighting operating mode, and this change can be tested. To configure another switch start back at step 1.

(7) Remote Deactivation of the 8 Momentary switches:

Any of the 11 lighting control switches plus the slide switch 'OFF' position can be configured to remotely deactivate any of the 8 momentary lighting control switches.

Factory Default: No momentary switches are remotely deactivated.

(DIP SWITCH SETTING: SWITCH 1 ON / SWITCH 4 OFF)

To deactivate Momentary Switches:

1. Put the unit into Momentary Switch Deactivation Mode:

- Place the SLIDE SWITCH in the OFF position and turn all momentary switches off.
- Press and hold the WAIL switch.
- Press and release momentary switch 10.
- Release the WAIL switch.

To confirm entry into this configuration mode, LEDs 3 & 4 on the Arrow indicator will light up.

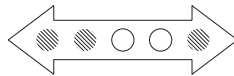

2. Select a switch to be configured:

To select a momentary switch:

- Press and release the momentary switch that you wish to configure.

OR...

To select a slide switch position:

- Move the slide switch to the position that you wish to configure (including the OFF position).
- Press and release the MANUAL switch.

All switch indicator lights whose corresponding switch is already configured to be deactivated by the selected Switch will turn on steady

1. Add or delete momentary switches deactivated by the selected switch:

- Press and release one of the 8 momentary switches to add or delete it from the selected switch's configuration. The switch's indicator light will turn on steady when its corresponding switch is selected to be deactivated.

2. Store and activate the selected switch's configuration:

- Place the SLIDE SWITCH in the OFF position.
- Press and release the WAIL switch.

All of the indicator lights will turn off and the data will be stored. This will put the unit back into lighting operating mode, and this change can be tested. To configure another switch, start back at step 1.

(8) Copying a units configuration:

If there is more than one unit that needs to be configured to operate in the same manor, it is not necessary to configure each unit separately. Once one unit has been configured to operate as desired, it can be used as the "primary" unit and its configuration can be copied to another unit that is set up as a "secondary" unit.

To copy a configuration to a second unit:

(DIP SWITCH SETTING: SWITCH 1 ON / SWITCH 4 OFF)

1. Wire the units as follows:

- Connect J7 on both units to a common power source (PIN1 to (+)V BAT & PIN 4 to Ground).
- Connect pin 10 of J5 on the "primary" unit to pin 5 of J5 on the "secondary" unit.
- Connect pin 1 of J5 of both units to (+)V BAT, Leave all other wiring unconnected.

2. Put the "PRIMARY" unit into "transmit" mode:

- Place the SLIDE SWITCH in the OFF position and turn all Momentary switches off.
- Press and hold the RADIO switch.
- Press and release momentary switch 10.
- Release the RADIO switch.

To confirm entry into "transmit" mode, LEDs 4 and 5 on the Arrow indicator will light up.

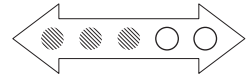

3. Put the "SECONDARY" unit into "receive" mode:

- Place the SLIDE SWITCH in the OFF position and turn all Momentary switches off.
- Press and hold the RADIO switch.
- Press and release momentary switch 9.
- Release the RADIO switch.

To confirm entry into "receive" mode, LEDs 3 and 5 on the Arrow indicator will light up.

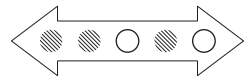

4. Transfer the Configuration:

- Watch the 3 slide switch indicators on the "SECONDARY" unit, when the left most indicator turns on, proper communications have been established.
- Press and release momentary switch 4 on the "primary" unit to start the transfer.
- On the "PRIMARY" unit see that the left most indicator on the arrow turns on to indicate that the transfer has been started.
- Watch the 3 slide switch indicators on the "SECONDARY" unit, in 5 seconds the middle indicator turns on and transfer is complete.

NOTE: If the right slide switch indicator light on the "secondary" unit turns on, an error has occurred, press the RADIO on both units to start back at step 1.

5. Store and activate the configuration:

- Press and release the RADIO switch on both the "primary and secondary" units.

All of the indicator lights will turn off and the data will be stored. This will put both units back into lighting operating mode.

OR...

- Turn the power off on both the "primary and secondary" units.

To transfer the configuration to another unit start back at step 1.

(9) Changing between standard and Title 13 operation:

When in title 13 operation, the airhorn tone will not override the primary siren tone, in standard operation, the airhorn tone will override the primary siren tone.

Factory Default: standard operation.
(DIP SWITCH SETTING: SWITCH 1 ON / SWITCH 4 OFF)

To change between standard and Title 13 operation:

- Place the SLIDE SWITCH in the OFF position and turn all Momentary switches off.
- Press and hold the WAIL switch.
- Press and release momentary switch 4.
- Release the WAIL switch.

To confirm that the unit is in title 13 operation, LEDs 1, 3 and 5 on the Arrow indicator will light up for two seconds.

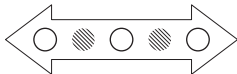

To confirm that the unit is in standard operation, LEDs 1 and 5 on the Arrow indicator will light up for two seconds.

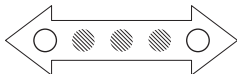

All of the indicator lights will turn off and the operation change will be stored. This will put the unit back into lighting operating mode.

NOTE: The siren operations cannot be tested until the unit is out of programming mode (i.e. all dip switches ON)

(10) Programming a tone set of Title 13 tones:

This procedure will program the unit with a default set of tones that will meet title 13 requirements, and will change the unit to operate under title 13 guidelines as described in Section (8).

(DIP SWITCH SETTING: SWITCH 1 ON / SWITCH 4 OFF)

Programming a tone set of Title 13 tones:

- Place the SLIDE SWITCH in the OFF position and turn all Momentary switches off.
- Press and hold the WAIL switch.
- Press and release momentary switch 5.
- Release the WAIL switch.

To confirm that the title 13 defaults have been set, LEDs 1 and 4 on the Arrow indicator will light up for two seconds.

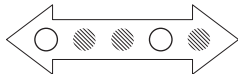

All of the indicator lights will turn off and the title 13 defaults will be stored. This will put the unit back into lighting operating mode.

NOTE: The siren cannot be tested until the unit is out of programming mode (i.e. all dip switches ON)

(10) Changing Red indicator intensity:

This procedure will allow adjustments to be made of the intensity of the red indicator LEDs on the control head.

Factory Default: 50%.

To adjust the red LED indicator:

(DIP SWITCH SETTING: SWITCH 1 ON / SWITCH 4 OFF)

1. Put the unit into "indicator adjustment" Mode:

- Place the SLIDE SWITCH in the OFF position and turn all Momentary switches off.
- Press and hold the WAIL switch.
- Press and release momentary switch 6.
- Release the WAIL switch.

To confirm that the unit is in title 13 operation, LEDs 2, 3 and 4 on the Arrow indicator will light up for two seconds.

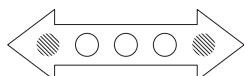

2. To make them brighter:

- Press and release the MANUAL switch until the desired intensity has been met.

OR...

To make them dimmer:

- Press and release the AIRHORN switch until the desired intensity has been met.

3. Store and activate the indicator intensity.

- Press and release the WAIL switch.

All of the indicator lights will turn off and the indicator intensity will be stored. This will put the unit back into lighting operating mode.

(11) - Changing Backlight intensity:

This procedure will allow adjustments to be made of the intensity of the backlight LEDs on the control head.

Factory Default: 50%. **To adjust the backlight:**

(DIP SWITCH SETTING: SWITCH 1 ON / SWITCH 4 OFF)

1. Put the unit into "backlight adjustment" Mode:

- Place the SLIDE SWITCH in the OFF position and turn all Momentary switches off.
- Connect J5 PIN 5 to +VBAT (To turn on the backlight).
- Press and hold the WAIL switch.
- Press and release momentary switch 7.
- Release the WAIL switch.

To confirm entry into "backlight adjustment" mode, LEDs 1 and 2 on the Arrow indicator will light up.

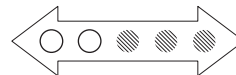

2. To make them brighter:

- Press and release the MANUAL switch until the desired intensity has been met.

OR...

To make them dimmer:

- Press and release the AIRHORN switch until the desired intensity has been met.

3. Store and activate the backlight intensity.

- Press and release the WAIL switch.

All of the indicator lights will turn off and the backlight intensity will be stored. This will put the unit back into lighting operating mode.

(12) Changing SHUTDOWN DELAY:

This procedure will allow adjustments to the time that the unit will operate after the UNIT ENABLE input becomes inactive.

Factory Default: OFF immediately

To adjust the Shutdown Delay:

(DIP SWITCH SETTING: SWITCH 1 ON / SWITCH 4 OFF)

1. Put the unit into "Shutdown Delay adjustment" Mode:

- Place the SLIDE SWITCH in the OFF position and turn all Momentary switches off.
- Press and hold the WAIL switch.
- Press and release momentary switch 8.
- Release the WAIL switch.

To confirm entry into "Shutdown Delay adjustment" mode, the Arrow indicator will display this pattern: (arrow leds 2,4)

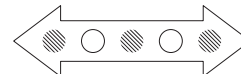

2. To adjust the time of operation

- Press and release the AIRHORN switch to cycle through time choices until the desired time has been met (table 3)

3. Store and activate the time of operation.

- Press and release the WAIL switch.

All of the indicator lights will turn off and the shutdown delay will be stored. This will put the unit back into lighting operating mode.

Table 3			
①	②	③	Slide Switch Indicators
●	●	●	OFF Immediately
○	●	●	1 minute
●	○	●	10 minutes
○	○	●	30 minutes
●	●	○	1 hour
○	●	○	2 hours
●	○	○	4 hours
○	○	○	8 hours
●	○	○	● = OFF ○ = ON

(13) Changing Siren Disable operation:

Siren disable can be configured to operate in one of two ways:

CANCEL: When one of the SIREN DISABLE inputs (see wiring diagram) becomes active the siren tones will deactivate, but siren tones can be reactivated manually through the control head while the SIREN DISABLE input is still active.

PAUSE Operation: When one of the SIREN DISABLE inputs (see wiring diagram) becomes active the siren tones will deactivate and siren tones will become reactivated when the SIREN DISABLE input becomes inactive.

Factory Default: CANCEL Operation.

(DIP SWITCH SETTING: SWITCH 1 ON / SWITCH 4 OFF)

To change between standard and Alternate Operation:

- Place the SLIDE SWITCH in the OFF position and turn all Momentary switches off.
- Press and hold the WAIL switch.
- Press and release momentary switch 9.
- Release the WAIL switch.

To confirm that the unit is in **PAUSE Operation** LEDs 1, 2 and 3 on the Arrow indicator will light up for two seconds.

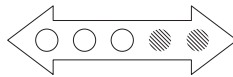

To confirm that the unit is in **CANCEL Operation**, LEDs 1 and 3 on the Arrow indicator will light up for two seconds.

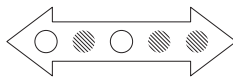

After two seconds all of the indicator lights will turn off and the operation change will be stored. This will put the unit back into programming mode.

NOTE: The siren operations cannot be tested until the unit is out of programming mode (i.e. all dip switches ON)

Programming Siren tones:

DIP SWITCH SETTING: Put the unit into "tone programming mode" by placing DIP switch 1 into the OFF position and DIP switch 4 in the ON position (see wiring for DIP switch location). With the DIP switches in this position lighting functions are disabled, leaving the siren functions and tone programming active.

To change the primary tone for the WAIL and YELP switch positions:

- Activate the switch position that you wish to change.
- Press and release the lighting momentary switch 4 to change the tone produced.
- When the desired tone is generated, it is automatically saved in that switch position for the speaker.

To change the override tone for the WAIL and YELP switch positions:

- Activate the switch position that you wish to change.
- Press and release the MANUAL switch to produce it's override tone.
- Press and release the lighting momentary switch 4 to change the tone produced.
- Each time a switch is pressed and released, the next available tone will be broadcast on the corresponding speaker.
- When the desired tone is generated, it is automatically saved as the override tone in that switch position for the speaker.

Tone list for Wail, Yelp and their override tones, and all hf positions:			
• Tone off	• Yelp 249	• Mechanical	• Woop
• Wail	• Piercer	• Warble	• Wail Yelp combo
• Yelp	• Hilo	• Phased Warble	• Wail Yelp Y429 Piercer Combo

To change the tones in a HANDS FREE cycle position (STANDBY switch):

- Activate the STANDBY switch.
- Press and release the MANUAL switch to advance to the HAND FREE cycle position that you want to change.
- Press and release the lighting momentary switch 4 to change the tone produced.
- Each time a switch is pressed and released, the next available tone will be broadcast on the corresponding speaker.
- When the desired tone is generated, it is automatically saved for that HAND FREE cycle position for the speaker.

Tone list for the MANUAL button:	
• Wail coast	• Mechanical stop
• Wail Stop	• Tone Off
• Mechanical coast	

Tone List for Airhorn button:	
• Tone off	
• Airhorn	
• Airhorn low	

To change the tone for the MANUAL and AIRHORN switch:

- Press and hold the MANUAL or AIRHORN switch.
- Press and release the lighting momentary switch 4 to change the tone.
- Each time a switch is pressed and released, the next available tone will be broadcast on the corresponding speaker.
- When the desired tone is generated, it is automatically saved for the chosen switch for that speaker.

(14) Changing Howler Run Time:

This procedure will allow adjustments to the length of time that the unit will operate the Howler tone.

Factory Default: 7 seconds

To adjust the Howler run time:

(DIP SWITCH SETTING: SWITCH 1 ON / SWITCH 4 OFF)

1. Put the unit into "Howler run time" Mode:

- Place the SLIDE SWITCH in the OFF position, turn all Momentary switches off.
- Press and hold the WAIL switch.
- Press and release momentary switch 11
- Release the WAIL switch.

To confirm entry into "Shutdown Delay adjustment" mode, the Arrow indicator will display this pattern: (arrow leds 3, 4, 5)

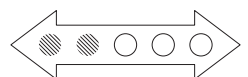

2. To adjust the time of operation

- Press and release the AIRHORN switch to cycle through time choices until the desired time has been met (table 4)

3. Store and activate the time of operation.

- Press and release the WAIL switch.

All of the indicator lights will turn off and the shutdown delay will be stored. This will put the unit back into lighting operating mode.

NOTE: The siren cannot be tested until the unit is out of programming mode (i.e. all dip switches ON)

Dip Switch Settings:				USE SWITCH 1 & 4 FOR PROGRAMMING. USE SWITCH 2 & 3 FOR HOWLER OPERATION
SW1	SW2	SW3	SW4	Operation
ON	N/A	N/A	OFF	Programming lighting
OFF	N/A	N/A	ON	Programming Siren tones
ON	ON	ON	ON	Howler Off
ON	OFF	ON	ON	Howler tone runs at 4 times siren tone
ON	ON	OFF	ON	Howler tone runs at 2 times siren tone
ON	OFF	OFF	ON	Howler tone runs at 4 times alternating with 2 times the siren tone

Any other Dip Switch setting combinations are not valid and are not recommended. N/A = Not applicable