

WHELEN[®]

ENGINEERING COMPANY INC.

51 Winthrop Road
Chester, Connecticut 06412-0684
Phone: (860) 526-9504
Fax: (860) 526-4078
Internet: www.whelen.com
Sales e-mail: autosale@whelen.com
Canadian Sales e-mail: canadiansales@whelen.com
Customer Service e-mail: custserv@whelen.com

Installation Guide:
R65 Liberty™ II WeCan® Lightbar

Warnings to Installers

Whelen's emergency vehicle warning devices must be properly mounted and wired in order to be effective and safe. Read and follow all of Whelen's written instructions when installing or using this device. Emergency vehicles are often operated under high speed stressful conditions which must be accounted for when installing all emergency warning devices. Controls should be placed within convenient reach of the operator so that they can operate the system without taking their eyes off the roadway. Emergency warning devices can require high electrical voltages and/or currents. Properly protect and use caution around live electrical connections. Grounding or shorting of electrical connections can cause high current arcing, which can cause personal injury and/or vehicle damage, including fire. Many electronic devices used in emergency vehicles can create or be affected by electromagnetic interference. Therefore, after installation of any electronic device it is necessary to test all electronic equipment simultaneously to insure that they operate free of interference from other components within the vehicle. Never power emergency warning equipment from the same circuit or share the same grounding circuit with radio communication equipment. All devices should be mounted in accordance with the manufacturer's instructions and securely fastened to vehicle elements of sufficient strength to withstand the forces applied to the device. Driver and/or passenger air bags (SRS) will affect the way equipment should be mounted. This device should be mounted by permanent installation and within the zones specified by the vehicle manufacturer, if any. Any device mounted in the deployment area of an air bag will damage or reduce the effectiveness of the air bag and may damage or dislodge the device. Installer must be sure that this device, its mounting hardware and electrical supply wiring does not interfere with the air bag or the SRS wiring or sensors. Mounting the unit inside the vehicle by a method other than permanent installation is not recommended as unit may become dislodged during swerving; sudden braking or collision. Failure to follow instructions can result in personal injury. Whelen assumes no liability for any loss resulting from the use of this warning device. PROPER INSTALLATION COMBINED WITH OPERATOR TRAINING IN THE PROPER USE OF EMERGENCY WARNING DEVICES IS ESSENTIAL TO INSURE THE SAFETY OF EMERGENCY PERSONNEL AND THE PUBLIC.

Warnings to Users

Whelen's emergency vehicle warning devices are intended to alert other operators and pedestrians to the presence and operation of emergency vehicles and personnel. However, the use of this or any other Whelen emergency warning device does not guarantee that you will have the right-of-way or that other drivers and pedestrians will properly heed an emergency warning signal. Never assume you have the right-of-way. It is your responsibility to proceed safely before entering an intersection, driving against traffic, responding at a high rate of speed, or walking on or around traffic lanes. Emergency vehicle warning devices should be tested on a daily basis to ensure that they operate properly. When in actual use, the operator must ensure that both visual and audible warnings are not blocked by vehicle components (i.e.: open trunks or compartment doors), people, vehicles, or other obstructions. It is the user's responsibility to understand and obey all laws regarding emergency warning devices. The user should be familiar with all applicable laws and regulations prior to the use of any emergency vehicle warning device. Whelen's audible warning devices are designed to project sound in a forward direction away from the vehicle occupants. However, because sustained periodic exposure to loud sounds can cause hearing loss, all audible warning devices should be installed and operated in accordance with the standards established by the National Fire Protection Association.

Safety First

This document provides all the necessary information to allow your Whelen product to be properly and safely installed. Before beginning the installation and/or operation of your new product, the installation technician and operator must read this manual completely. Important information is contained herein that could prevent serious injury or damage.

- **Proper installation of this product requires the installer to have a good understanding of automotive electronics, systems and procedures.**
- **Whelen Engineering requires the use of waterproof butt splices and/or connectors if that connector could be exposed to moisture.**
- **Failure to use specified installation parts and/or hardware will void the product warranty.**
- **If mounting this product requires drilling holes, the installer MUST be sure that no vehicle components or other vital parts could be damaged by the drilling process. Check both sides of the mounting surface before drilling begins. Also de-burr the holes and remove any metal shards or remnants. Install grommets into all wire passage holes.**
- **If this manual states that this product may be mounted with suction cups, magnets, tape or Velcro®, clean the mounting surface with a 50/50 mix of isopropyl alcohol and water and dry thoroughly.**
- **Do not install this product or route any wires in the deployment area of your air bag. Equipment mounted or located in the air bag deployment area will damage or reduce the effectiveness of the air bag, or become a projectile that could cause serious personal injury or death. Refer to your vehicle owner's manual for the air bag deployment area. The User/Installer assumes full responsibility to determine proper mounting location, based on providing ultimate safety to all passengers inside the vehicle.**
- **For this product to operate at optimum efficiency, a good electrical connection to chassis ground must be made. The recommended procedure requires the product ground wire to be connected directly to the NEGATIVE (-) battery post (this does not include products that use cigar power cords).**
- **If this product uses a remote device for activation or control, make sure that this device is located in an area that allows both the vehicle and the device to be operated safely in any driving condition.**
- **Do not attempt to activate or control this device in a hazardous driving situation.**
- **This product contains either strobe light(s), halogen light(s), high-intensity LEDs or a combination of these lights. Do not stare directly into these lights. Momentary blindness and/or eye damage could result.**
- **Use only soap and water to clean the outer lens. Use of other chemicals could result in premature lens cracking (crazing) and discoloration. Lenses in this condition have significantly reduced effectiveness and should be replaced immediately. Inspect and operate this product regularly to confirm its proper operation and mounting condition. Do not use a pressure washer to clean this product.**
- **It is recommended that these instructions be stored in a safe place and referred to when performing maintenance and/or reinstallation of this product.**
- **FAILURE TO FOLLOW THESE SAFETY PRECAUTIONS AND INSTRUCTIONS COULD RESULT IN DAMAGE TO THE PRODUCT OR VEHICLE AND/OR SERIOUS INJURY TO YOU AND YOUR PASSENGERS!**

IMPORTANT! The lightbar must be a minimum of 16" from any radio antennas.

NOTE: There may be a roof support member that spans the distance between the driver's and passengers side. **DO NOT DRILL THROUGH THIS MEMBER!** Adjust the location until the holes can be drilled without contacting this support member.

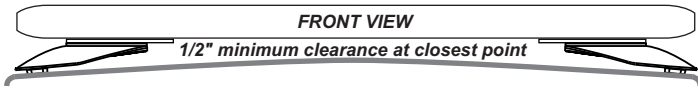

Unless otherwise specified, lightbar mounting feet must be sitting as close to the edge of the roof as possible and not be hanging off the edge.

IMPORTANT: For strap mounted lightbars, be sure you have the right sized bar for your vehicle. The lightbar should be approximately the same width as the vehicle roof. If too large or small it will not mount properly to the vehicle and may come loose during driving.

Fig. 1

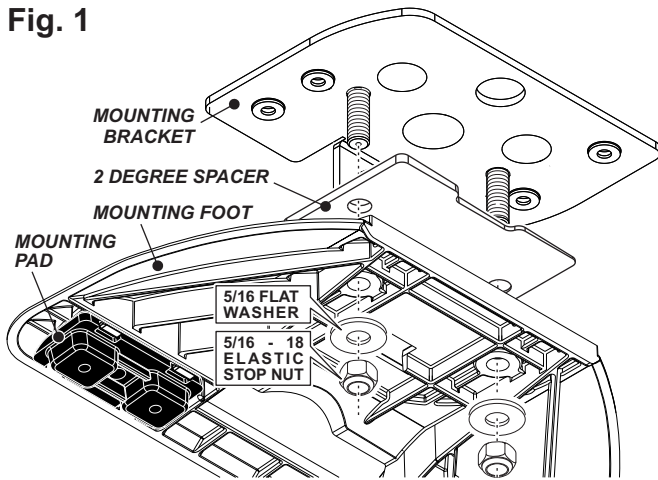

Insert round side of bracket under lip in extrusion

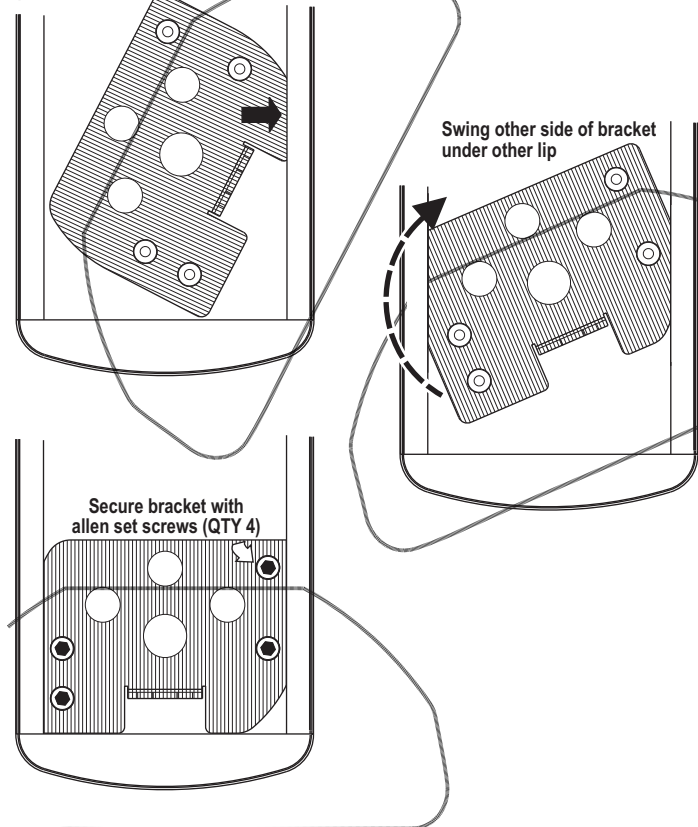
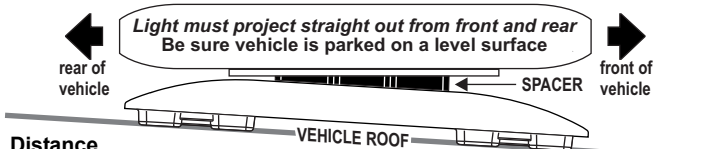

Fig. 2

Strap Mounting:

1. Install the mounting bracket to the mounting foot using the supplied 5/16 FLAT WASHERS and 5/16 - 18 ELASTIC STOP NUTS (Fig. 1). Do NOT install the optional spacers yet.
2. Place the bracket into the track on the bottom of the extruded base of the lightbar and twist it into position (Fig. 2).
3. Slide the bracket to the outer end of the base extrusion and secure the bracket to the extrusion using the four 1/4 - 20 X 1/2 ALLEN SET SCREWS (Fig. 2). Repeat steps 1 - 3 for other side of lightbar.
4. **Installing Spacers:** Spacers are used as required to adjust the lightbars clearance from the vehicle roof. Spacers are also used to make the lightbar level with the road so that the light does not project up or down when viewed from the front or rear of the vehicle. Each spacer creates a 2° incline.

Lightbar angle: Place the lightbar onto the vehicle roof in its exact mounting location and use a level to check the angle of the lightbar. If (because of the curvature of the vehicle roof) the front and rear lights project up or down, you will need to install one of the supplied spacers. Note the angle of the tilt to determine where to place the spacer. **Installation:** Remove the mounting feet (not the bracket) and install the spacer (maximum 1 per side) then reinstall the feet.



Distance

from roof: The lightbar must be no closer than 1/2 inch (at the closest point) from the vehicle roof. **Installation:** Remove the mounting feet (not the bracket), install the spacers as shown (maximum 2 per side) and reinstall feet.

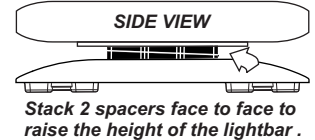
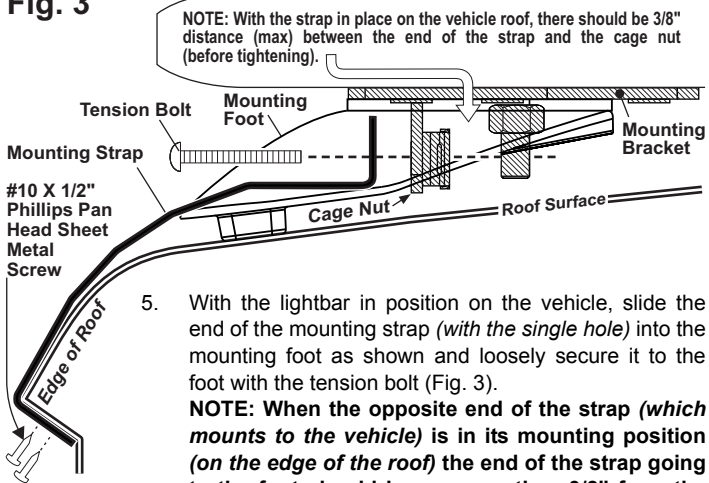
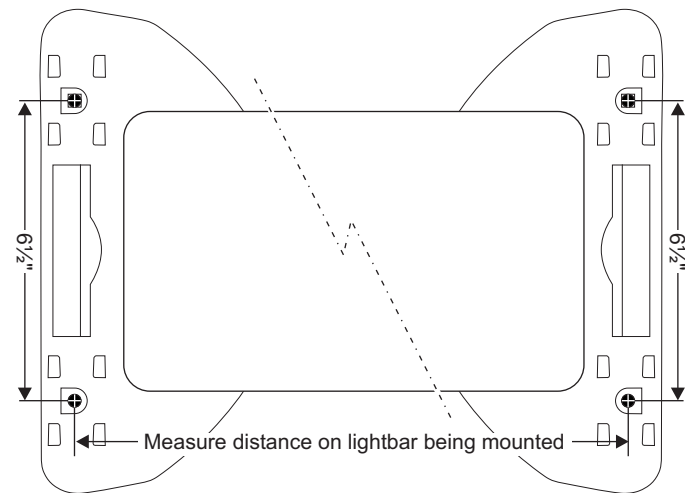

Fig. 3



5. With the lightbar in position on the vehicle, slide the end of the mounting strap (with the single hole) into the mounting foot as shown and loosely secure it to the foot with the tension bolt (Fig. 3). **NOTE:** When the opposite end of the strap (which mounts to the vehicle) is in its mounting position (on the edge of the roof) the end of the strap going to the foot should be no more than 3/8" from the cage nut it mounts to. If the distance from the strap to the cage nut is greater than 3/8", remove the lightbar from the vehicle and move both mounting feet the necessary distance to correct this before doing step 5.
6. Bring the outside of the mounting strap down to the edge of the vehicle roof. The outer end of the strap should hook around the roof (Fig. 3). Mounting straps are made for specific vehicles and the one designed for your vehicle will conform to the edge of that roof.
7. Make sure the strap is in position on the edge of the roof and the other end lines up properly with the cage nut. Drill two holes for a #10 screw through the two mounting holes in the strap and secure the strap with the two #10 X 1/2" PHILLIPS PAN HEAD SHEET METAL SCREWS.
8. Tighten the tension bolt firmly to secure the foot to the vehicle.

Permanent Mounting:



Caution: Permanent mounting of this product will require drilling. It is absolutely necessary to make sure that no other vehicle components could be damaged by this process. Check both sides of the mounting surface before starting. If damage is likely, select a different mounting location.

1. Install the mounting foot to the lightbar following steps 1 thru 4 of "Strap Mounting".

Routing the Lightbar Cable(s):

1. To protect the headliner from damage caused by drilling the cable access hole through the vehicle roof, allow a 5" to 7" distance between roof and headliner by lowering the headliner before drilling.
2. Using a 1" hole saw, drill the cable access hole then use a round file to smooth and de-burr the edges of the hole. Install a 1" grommet (user supplied).

NOTE: There may be a roof support member that spans the distance between the driver's and passenger's side. **DO NOT DRILL THROUGH THIS MEMBER!** Adjust the location until the hole can be drilled without contacting this support member.

3. Insert the cable(s) through the cable access hole into the vehicle. Use RTV silicone to weatherproof the access hole after the cable(s) are pulled completely into the vehicle.
4. Route the cable(s) one at a time to their respective destinations (power cable to vehicle battery; control cable to switch panel). Refer to the instructions included with your switches for switch wiring information.

Drilling the Cable Access Hole

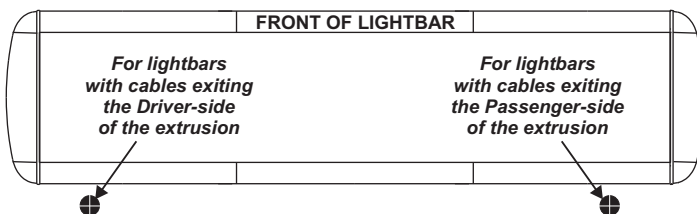

IMPORTANT AIR BAG WARNING! Refer to front cover for necessary air bag precautions.

Connecting the Power Cable:

WARNING! All customer supplied wires that connect to the positive terminal of the battery must be sized to supply at least 125% of the maximum operating current and **FUSED** at the battery to carry that load. **DO NOT USE CIRCUIT BREAKERS WITH THIS PRODUCT!**

1. Follow the factory wiring harness through the firewall. It may be necessary to drill a hole in the firewall. If so, be absolutely sure that there are no components that could be damaged by drilling. After the hole has been drilled, insert a grommet to protect the cable.

2. Position the lightbar onto the vehicle in its exact mounting location and mark the location of the mounting holes onto the mounting surface using the mounting feet as templates.

If the permanent mounting holes in the mounting feet are difficult to access, you can use the measurements shown here to mark off and drill the mounting holes. You will also need to measure the distance between the mounting feet for your application since lightbar width will depend on the lightbar you are mounting.

3. Remove the lightbar and drill the 4 mounting holes.

4. Install the lightbar using the supplied 1/4 - 20 Phillips Pan Head Metal Screw, 1/4" Internal Tooth Lock Washer and 1/4 - 20 X 7/16 Hex Nut.

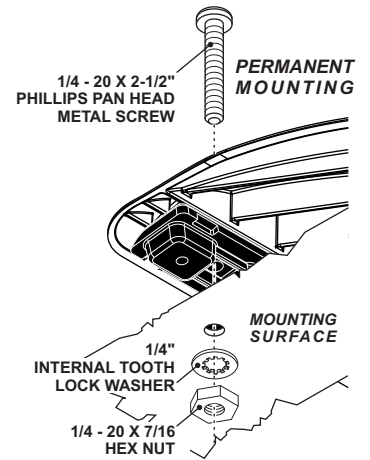

IMPORTANT! It is the responsibility of the installation technician to make sure that the installation and operation of this product will not interfere with or compromise the operation or efficiency of any vehicle equipment! Before returning the vehicle to active service, visually confirm the proper operation of this product, as well as all vehicle components/equipment.

2. Route the cable along the factory wiring harness towards the battery. Install a 50 amp fuse block (customer supplied) on the end of the RED wire in the power cable. **NOTE: Remove the fuse from the fuse block before connecting any wires to the battery.**
3. Connect the BLACK wire to Chassis Ground.

Connecting the Communication Cable:

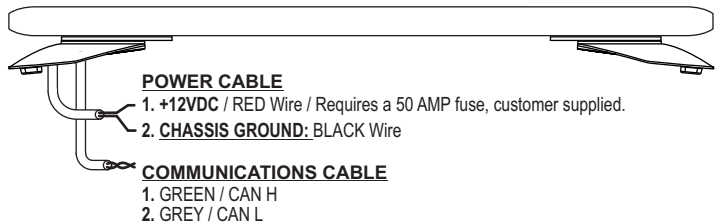

Splice the GREEN and GREY wires from the lightbar to the GREEN and GREY wires from the Controller.

Your lightbar should now be fully operational. If it is not functioning properly, check your connections for the following:

- The positive wire (RED) is properly connected to the battery, by way of the user supplied fuse block.
- A working 50 amp fuse is installed in the fuse block.
- The ground wire (BLACK) is properly connected to the factory ground. Be sure that the wire is fully grounded to this location.
- The two communication wires (GREEN and GREY) are properly connected to their communication designations.

Refer to your controller instructions for connections and operation.

IMPORTANT! It is the responsibility of the installation technician to make sure that the installation and operation of this product will not interfere with or compromise the operation or efficiency of any vehicle equipment!

IMPORTANT WARNING!

CAUTION! DO NOT LOOK DIRECTLY AT THESE LED'S WHILE THEY ARE ON. MOMENTARY BLINDNESS AND/OR EYE DAMAGE COULD RESULT!

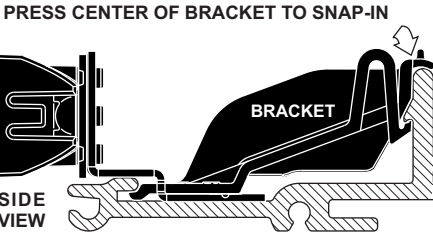
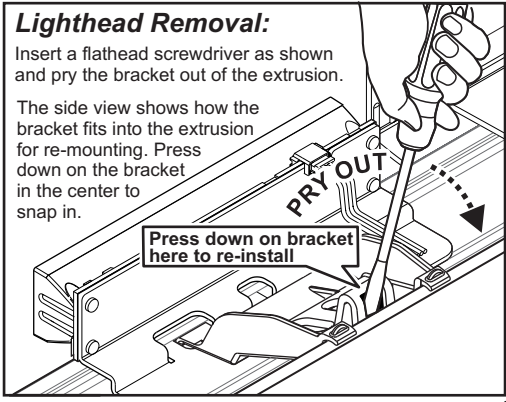

CAUTION: If you need to unplug a wire harness connector from a lighthouse, **DO NOT PULL ON THE WIRES!** Very carefully pull the connector straight out of the lighthouse. Pulling on the wires will damage the harness and void the warranty.

Accessing the Lightbar:

1. Remove the screws which hold on the metal panel on top.
2. Remove the two endcap screws.
3. Slide the lens off of the extrusion.

NOTE:
 When reassembling the lightbar be sure the gaskets and divider line up and fit properly.

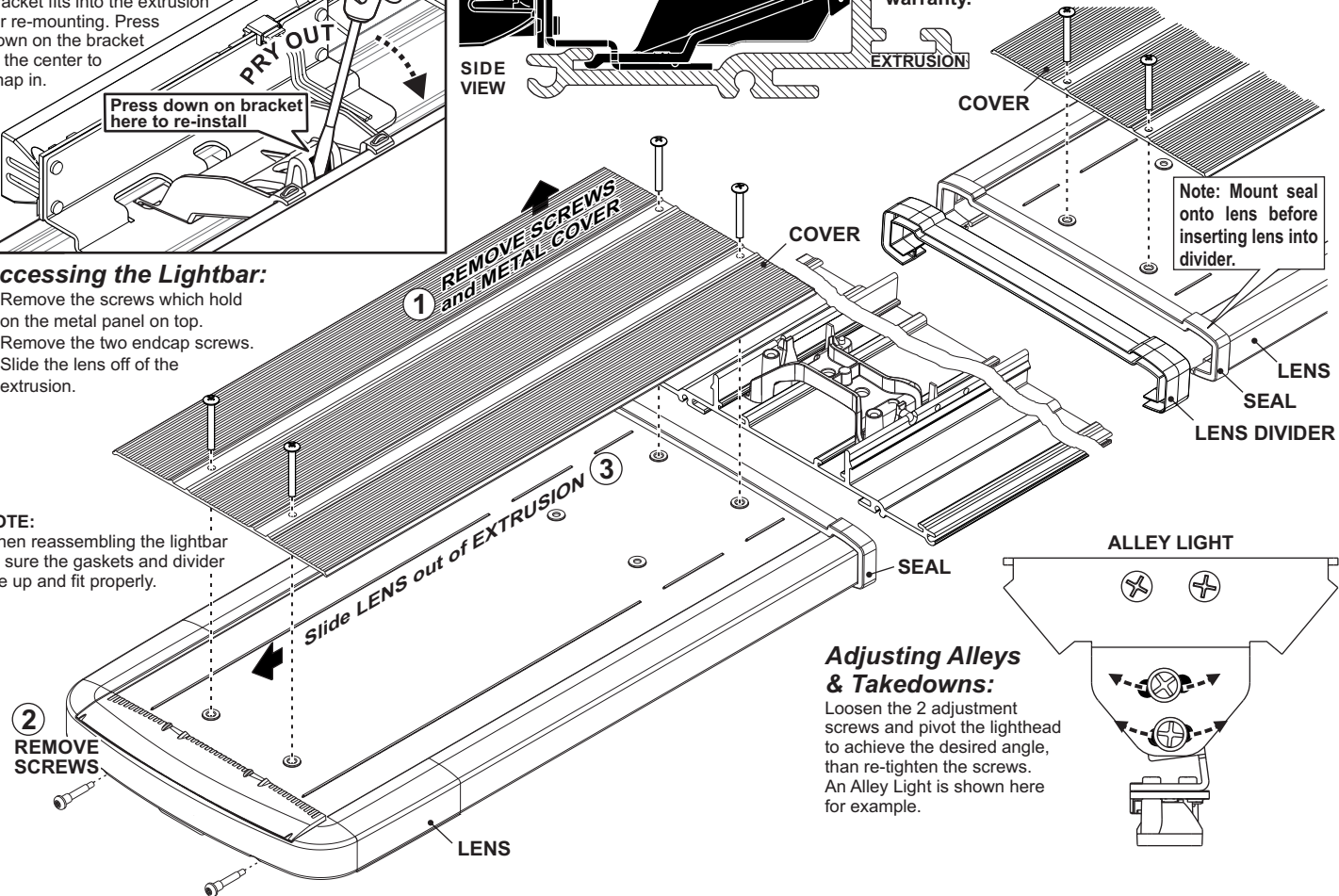

Adjusting Alleys & Takedowns:

Loosen the 2 adjustment screws and pivot the lighthouse to achieve the desired angle, then re-tighten the screws. An Alley Light is shown here for example.

