

# WHELEN<sup>®</sup>

## ENGINEERING COMPANY INC.

51 Winthrop Road  
Chester, Connecticut 06412-0684  
Phone: (860) 526-9504  
Fax: (860) 526-4078  
Internet: [www.whelen.com](http://www.whelen.com)  
Sales e-mail: [autosale@whelen.com](mailto:autosale@whelen.com)  
Canadian Sales e-mail: [canadiansales@whelen.com](mailto:canadiansales@whelen.com)  
Customer Service e-mail: [custserv@whelen.com](mailto:custserv@whelen.com)

### Installation Guide: CenCom™ Carbide Siren/Light Control System

**DANGER!** Sirens produce extremely loud emergency warning tones! Exposure to these tones without proper and adequate hearing protection, could cause ear damage and/or hearing loss! The Occupational Safety & Health Administration ([www.osha.gov](http://www.osha.gov)) provides information necessary to determine safe exposure times in Occupational Noise Exposure Section 1910.95. Until you have determined the safe exposure times for your specific application, operators and anyone else in the immediate vicinity should be required to wear an approved hearing protection device. FAILURE TO FOLLOW THIS RECOMMENDATION COULD CAUSE HEARING LOSS!

#### Warnings to Installers

Whelen's emergency vehicle warning devices must be properly mounted and wired in order to be effective and safe. Read and follow all of Whelen's written instructions when installing or using this device. Emergency vehicles are often operated under high speed stressful conditions which must be accounted for when installing all emergency warning devices. Controls should be placed within convenient reach of the operator so that he can operate the system without taking his eyes off the roadway. Emergency warning devices can require high electrical voltages and/or currents. Properly protect and use caution around live electrical connections. Grounding or shorting of electrical connections can cause high current arcing, which can cause personal injury and/or vehicle damage, including fire. Many electronic devices used in emergency vehicles can create or be affected by electromagnetic interference. Therefore, after installation of any electronic device it is necessary to test all electronic equipment simultaneously to insure that they operate free of interference from other components within the vehicle. Never power emergency warning equipment from the same circuit or share the same grounding circuit with radio communication equipment. All devices should be mounted in accordance with the manufacturer's instructions and securely fastened to vehicle elements of sufficient strength to withstand the forces applied to the device. Driver and/or passenger air bags (SRS) will affect the way equipment should be mounted. This device should be mounted by permanent installation and within the zones specified by the vehicle manufacturer, if any. Any device mounted in the deployment area of an air bag will damage or reduce the effectiveness of the air bag and may damage or dislodge the device. Installer must be sure that this device, its mounting hardware and electrical supply wiring does not interfere with the air bag or the SRS wiring or sensors. Mounting the unit inside the vehicle by a method other than permanent installation is not recommended as unit may become dislodged during swerving; sudden braking or collision. Failure to follow instructions can result in personal injury. Whelen assumes no liability for any loss resulting from the use of this warning device. PROPER INSTALLATION COMBINED WITH OPERATOR TRAINING IN THE PROPER USE OF EMERGENCY WARNING DEVICES IS ESSENTIAL TO INSURE THE SAFETY OF EMERGENCY PERSONNEL AND THE PUBLIC.

#### Warnings to Users

Whelen's emergency vehicle warning devices are intended to alert other operators and pedestrians to the presence and operation of emergency vehicles and personnel. However, the use of this or any other Whelen emergency warning device does not guarantee that you will have the right-of-way or that other drivers and pedestrians will properly heed an emergency warning signal. Never assume you have the right-of-way. It is your responsibility to proceed safely before entering an intersection, driving against traffic, responding at a high rate of speed, or walking on or around traffic lanes. Emergency vehicle warning devices should be tested on a daily basis to ensure that they operate properly. When in actual use, the operator must ensure that both visual and audible warnings are not blocked by vehicle components (i.e.: open trunks or compartment doors), people, vehicles, or other obstructions. It is the user's responsibility to understand and obey all laws regarding emergency warning devices. The user should be familiar with all applicable laws and regulations prior to the use of any emergency vehicle warning device. Whelen's audible warning devices are designed to project sound in a forward direction away from the vehicle occupants. However, because sustained periodic exposure to loud sounds can cause hearing loss, all audible warning devices should be installed and operated in accordance with the standards established by the National Fire Protection Association.

#### Safety First

This document provides all the necessary information to allow your Whelen product to be properly and safely installed. Before beginning the installation and/or operation of your new product, the installation technician and operator must read this manual completely. Important information is contained herein that could prevent serious injury or damage.

- Proper installation of this product requires the installer to have a good understanding of automotive electronics, systems and procedures.
- Whelen Engineering requires the use of waterproof butt splices and/or connectors if that connector could be exposed to moisture.
- Failure to use specified installation parts and/or hardware will void the product warranty.
- If mounting this product requires drilling holes, the installer MUST be sure that no vehicle components or other vital parts could be damaged by the drilling process. Check both sides of the mounting surface before drilling begins. Also de-burr the holes and remove any metal shards or remnants. Install grommets into all wire passage holes.
- If this manual states that this product may be mounted with suction cups, magnets, tape or Velcro®, clean the mounting surface with a 50/50 mix of isopropyl alcohol and water and dry thoroughly.
- Do not install this product or route any wires in the deployment area of your air bag. Equipment mounted or located in the air bag deployment area will damage or reduce the effectiveness of the air bag, or become a projectile that could cause serious personal injury or death. Refer to your vehicle owner's manual for the air bag deployment area. The User/Installer assumes full responsibility to determine proper mounting location, based on providing ultimate safety to all passengers inside the vehicle.
- For this product to operate at optimum efficiency, a good electrical connection to chassis ground must be made. The recommended procedure requires the product ground wire to be connected directly to the NEGATIVE (-) battery post (this does not include products that use cigar power cords).
- If this product uses a remote device for activation or control, make sure that this device is located in an area that allows both the vehicle and the device to be operated safely in any driving condition.
- It is recommended that these instructions be stored in a safe place and referred to when performing maintenance and/or reinstallation of this product.
- FAILURE TO FOLLOW THESE SAFETY PRECAUTIONS AND INSTRUCTIONS COULD RESULT IN DAMAGE TO THE PRODUCT OR VEHICLE AND/OR SERIOUS INJURY TO YOU AND YOUR PASSENGERS!

**ACTIVATION OF THIS  
SIREN MAY DAMAGE  
UNPROTECTED EARS!**



**CAUTION**  
Loud siren noise can cause hearing damage and/or loss. Refer to OSHA Section 1910.95 prior to putting ANY siren into service!

# Table of Contents

Specifications .....	page 3
Installation	
CenCom Module .....	page 4
Control Head Mounting .....	page 4
Microphone .....	page 4
Wiring	
System Power .....	page 6
Ignition Sense .....	page 6
Outputs .....	page 6
Siren Speaker .....	page 6
Radio Rebroadcast .....	page 6
Backlighting .....	page 6
Programmable Inputs .....	page 6
Park-Kill .....	page 6
Hands-Free Siren .....	page 6
Control Head Cable .....	page 6
CenCom Module Fuses .....	page 7
Isolated Relay (Outlet 10) .....	page 7
Input Expansion Module (Optional) .....	page 7
Adjustments	
Public Address (PA) Volume Adjustment .....	page 7
Radio Repeat Volume Adjustment .....	page 7
Control Head Default Configuration Tables .....	page 5
LED Indicators	
Traffic Advisor Indicators .....	page 8
Output Indicators .....	page 8
WC Diagnostic Indicators .....	page 8

## Illustrations

Bail Strap Mounting .....	page 4
Hands-Free Transfer Relay .....	page 6
Control Head Cable Strain Relief .....	page 4
CenCom Module Fusing Information .....	page 7
Isolated Relay (Outlet 10) .....	page 7
Input Expansion Module Pin-Outs .....	page 7
Wire Gage Chart .....	page 12
CenCom LED Indicators .....	page 8
System Wiring .....	page 9
CenCom Module Input/Output Wiring Identification .....	page 10
Configuration Record .....	page 11

# Specifications

## General

Input Voltage	12.8 VDC $\pm$ 20%
	Negative Ground Only
Main Input Current	80 Amps Max.
Main Siren Fuse	20 Amps
Stand-by Current (backlight off)	Ign.On - 80mA (typ) / Ign.Off - 100 uA (typ)
Operating Temperature	-30°C to +60°C
Storage Temperature	-40°C to +70°C
Humidity	99% (Non-condensing)
Output Load	Two, 11 Ohm Speakers
Output Power	Two, 100 Watt Speakers

## Output Current

Output #1	20 Amps Max. (fused@10 Amps)
Output #2	20 Amps Max. (fused@10 Amps)
Output #3	10 Amps Max. (fused@10 Amps)
Output #4	10 Amps Max. (fused@10 Amps)

**NOTE: Total combined current draw of Outputs 1, 2, 3 & 4 not to exceed 50 Amps!**

Output #5	10 Amps Max. (fused@10 Amps)
Output #6	10 Amps Max. (fused@10 Amps)
Output #7	10 Amps Max. (fused@10 Amps)
Output #8	10 Amps Max. (fused@10 Amps)
Output #9	10 Amps Max. (fused@10 Amps)

**NOTE: Total combined current draw of Outputs 5, 6, 7, 8 & 9 not to exceed 50 Amps!**

## Dimensions (CenCom Carbide Module)

Height	3.20 inches
Width	8.22 inches
Depth	6.74 inches

## Dimensions (Control Head)

Height	3.58 inches
Width	6.85 inches
Depth	1.32 inches

# Installation

## CenCom Module

1. Locate a suitable mounting location. A dry, cool compartment is a good choice.
2. Position the CenCom module on the proposed mounting location. Using an awl or similar tool, scribe the mounting surface where the mounting holes are to be drilled. Make sure that this mounting area allows sufficient ventilation for the CenCom module's air vents and fans.

**Caution:** As mounting the CenCom module will require drilling, it is absolutely necessary to make sure that no other vehicle components could be damaged in the process. Check both sides of the mounting surface before starting. If damage is likely, select a different mounting location.

3. Remove the module from its mounting area, and using a drill bit sized for a #10 sheet metal screw, drill a hole in each of the areas scribed in the previous step.
4. Return the module to its mounting location. Using #10 x 3/4" sheet metal screws (provided), secure the module onto its mounting surface. Be sure to install a #10 internal tooth lock washer (included) onto each mounting screw. **IMPORTANT:** The CenCom module case must be either mounted on, or grounded to the vehicle chassis.

## Control Head

The following sections will outline the various mounting styles available for the assorted CenCom control heads. The applicable mounting styles for each control head are listed on pages 5 thru 7.

Regardless of the style selected, be sure to observe the air bag warning on the cover of this manual.

**Caution:** As mounting the control head will require drilling, it is absolutely necessary to make sure that no other vehicle components could be damaged in the process. Check both sides of the mounting surface before starting. If damage is likely, select a different mounting location.

## Bail Strap Mount

1. Position the bail strap in the selected mounting location. Using an awl or other suitable tool, scribe the surface where the mounting holes are to be drilled.
2. Drill the mounting holes in the areas scribed in step 1. The size of the drill bit should be determined by the size of the mounting hardware (#10 sheet metal screw) and thickness of the mounting surface.
3. Using hardware provided (#10 x 3/4" sheet metal screw & #10 internal tooth lockwasher), secure the bail strap to the mounting location.

**Note:** There are 3 sets of holes on the bail strap for positioning the control head at 3 different heights.

4. With the bail strap in place, insert the #10 x 3/8" hex head bolt into the assembly hole from the inner side of the bail strap as shown.

Control head shown for reference-only

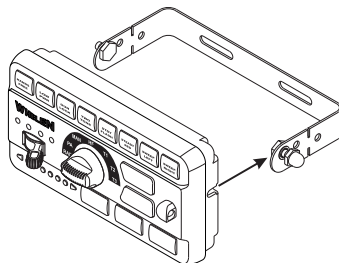

5. Place the #10 internal-tooth lock washer and the acorn nut on the protruding bolt on the outer side of the bail strap. Loosely secure the acorn nut to the hex head bolt.

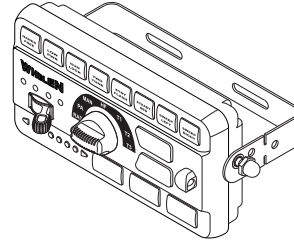

Now slide the control head onto the bolt heads. Once it is in the position that the customer has chosen, and the control head has fully engaged the bolt heads, tighten the acorn nuts until the unit is firmly secured.

A third pair of mounting holes are provided that will enable the control head to be located much closer to the bail strap than the other pairs allow. If this closer location is used, the tips of the bail bracket may be broken off at the notches shown.

Route the control head cable (provided) from the CenCom module to the designated mounting location. Plug this cable securely into the rear of the control head. Be sure to route the cable through either of the two recessed pathways (shown here). This will prevent the cable from being accidentally disconnected or pinched by the control head.

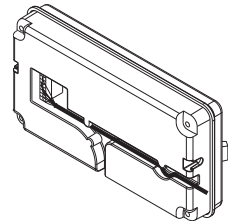

## Havis Console Mount

The Havis Console mounting kit includes all the necessary hardware needed to secure the control head to the mounting bracket for installation on a Havis Console. Please refer to the manual included with your console for specific information on securing the control head/mounting bracket assembly onto the console.

For installation into consoles by other manufacturers, a control head bracket designed for your console must be obtained from the console manufacturer.

## Microphone Mount

A 1/4" microphone port is provided on the front of the Amp/Relay module. After plugging the microphone cord into the microphone port, secure the cord using the cable clamp and #8 x 3/8" machine screw (included with microphone kit).

If the optional 20' extension cord is used, install this cord as outlined above. Install the mic plug bracket (included with kit) in the desired area using #8 x 1/2" hardware (included). Route the cord to the plug bracket, install the cable end thru the bracket hole and fasten using the hex nut provided. Secure the cord to the bracket using the cable clamp, #8 x 3/8" machine screw and lock washer.

## Default Control Head Configurations

The default operating configurations for the control heads available for the CenCom Carbide are listed in the following section.

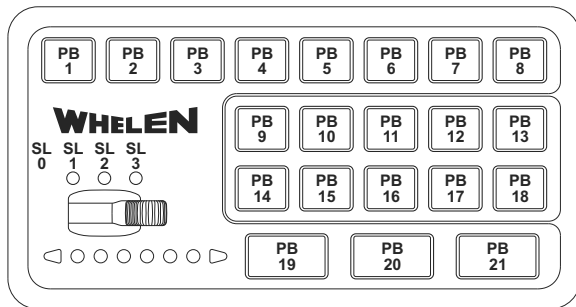

**Control Head:**  
21 Button  
w/Slide Switch

**Mounting Style(s):**  
Bail Mount  
Console Mount

ID	Default Function	Description
PB 1	STBY	Clears all siren operations. Activates Horn Relay.
PB 2	RAD	Rebroadcast radio output through siren speaker. Activates Horn Relay
PB 3	HF	Stand-by Mode, but Horn Ring or MAN button can activate the siren and be used to cycle through the Hands-Free buffer. Activates Horn Relay.

PB 4	WAIL	Broadcasts WAIL tone. Activates Horn Relay.
PB 4	WAIL	Broadcasts WAIL tone. Activates Horn Relay.
PB 5	YELP	Broadcasts YELP tone. Activates Horn Relay.
PB 6	T3	Broadcasts PIERCER tone. Activates Horn Relay.
PB 7	MAN	Initiates MANUAL tone. Applies OVERRIDE tone. Can cycle tones for Hands Free.
PB 8	AH	Broadcasts the AIRHORN Tone.
PB 9	SW9	Activates Output 8.
PB 10	SW10	Activates Output 9.
PB 11	AUX1	Activates Output 11.
PB 12	AUX2	Activates Horn Relay.
PB 13	LP	Activates Output 12.
PB 14	SW14	Activates Output 4.
PB 15	SW15	Activates Output 5.
PB 16	SW16	Activates Output 6.
PB 17	SW17	Activates Output 7.
PB 18	GL	Activates Output 10.
PB 19	LT T/A	Activates 'Sequence Left' Traffic Advisor pattern.
PB 20	RT T/A	Activates 'Sequence Right' Traffic Advisor pattern.
PB 21	FLSH	Sequence through three available Traffic Advisor flash patterns and "Off".
SL 0	OFF	Stops All Siren and T/A functions.
SL 1	1	Activates Output 1.
SL 2	2	Activates Output 1 + 2.
SL 3	3	Activates Output 1 + 2 + 3.

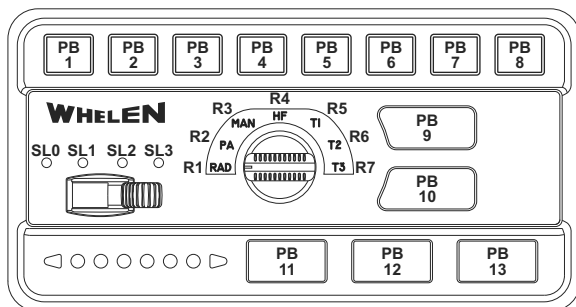

**Control Head:**  
13 Button  
w/Knob & Slide Switch

**Mounting Style(s):**  
Bail Mount  
Console Mount

ID	Default Function	Description
PB 1	SW1	Activates Output 4.
PB 2	SW2	Activates Output 5.
PB 3	SW3	Activates Output 6.
PB 4	SW4	Activates Output 7.
PB 5	AUX1	Activates Output 11.

PB 6	AUX2	Activates Horn Relay.
PB 7	LP	Activates Output 12.
PB 8	GL	Activates Output 10.
PB 9	MAN	Initiates Manual Tone. Applies Override Tone. Can cycle tones for Hands-Free.
PB 10	AH	Broadcast Airhorn Tone.
PB 11	LT T/A	Activates 'Sequence Left' Traffic Advisor pattern.
PB 12	RT T/A	Activates 'Sequence Right' Traffic Advisor pattern.
PB 13	FLSH	Sequence through three available Traffic Advisor flash patterns and "OFF".
R1	RAD	Rebroadcast radio output through the siren speaker. Activates Horn Relay.
R2	PA	Activate PA Feature. Turns off Hands-Free.
R3	MAN	Changes functionality of Horn Ring Input.
R4	HF	Stand-By mode except that the Horn Ring (or the MAN button) can activate the siren and be used to cycle through the Hands-Free buffer. Activates Horn Relay.
R5	T1	Broadcast WAIL tone. Activate Horn Relay.
R6	T2	Broadcast YELP tone. Activate Horn Relay.
R7	T3	Broadcast PIERCER tone. Activate Horn Relay.
SL0	OFF	Stops All Functions.
SL1	1	Activates Output 1.
SL2	2	Activates Output 1 + 2.
SL3	3	Activates Output 1 + 2 + 3.

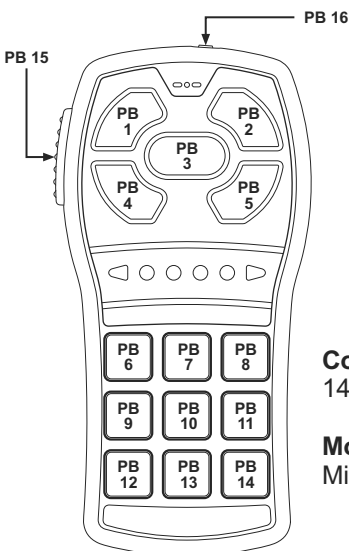

**Control Head:**  
14+2 Button

**Mounting Style:**  
Microphone Mount

ID	Default Function	Description
PB 1	SL1	Activates Output 1.
PB 2	SL2	Activates Output 1 + 2.
PB 3	SL3	Activates Output 1 + 2 + 3.
PB 4	MAN	Initiates MANUAL tone. Applies OVERRIDE tone. Can cycle tones for Hands Free.
PB 5	AH	Broadcasts AIRHORN Tone.
PB 6	HF	Stand-by Mode, but Horn Ring or MAN button can activate the siren and be used to cycle through the Hands-Free buffer. Activates Horn Relay.
PB 7	WAIL	Broadcasts the WAIL tone. Activates Horn Relay.
PB 8	YELP	Broadcasts the YELP tone. Activates Horn Relay.
PB 9	T3	Broadcasts PIERCER tone. Activates Horn Relay.
PB 10	RAD	Rebroadcast radio output through siren speaker. Activates Horn Relay
PB 11	DIR	Cycles through Traffic Advisor (Left, Right, Split, Off) states.
PB 12	SW10	Activates Output x.
PB 13	LP	Activates Output 10.
PB 14	GL	Releases Gun Lock
PB 15	P-T-T	Push-To-Talk (Microphone/PA)
PB 16	On/Off	Places system in Sleep mode.

## Wiring

**WARNING!** All customer supplied wires that connect to the positive terminal of the battery must be sized to supply at least 125% of the maximum operating current and **FUSED** at the battery to carry that load. **DO NOT USE CIRCUIT BREAKERS WITH THIS PRODUCT!** (see wire chart on page 12).

*NOTE: Item numbers reference the illustration found on page 10.*

**IMPORTANT!** Wires connecting to the Amp/Relay Module have the proper terminals pre-installed. If the customer needs to re-terminate these wires for any reason, the proper tool **MUST** be used to insure proper crimping.

### System Power (Items 48-51)

1. Locate the 4-position Molex™ connector (items 48 thru 51).
2. Using appropriately sized wire, extend the two RED wires (50 & 51) to the Positive (+) battery terminal. Fuse each wire independently @ 50 Amps. **DO NOT** install these fuses until the wiring for the entire system has been completed.
3. Using appropriately sized wire, extend the two BLACK wires (48 & 49) to the vehicle's chassis ground (typically adjacent to the battery).
4. Complete the connections and plug the connector into the CenCom™ module.

### Ignition Sense (Item 41)

1. Locate the RED/BLK wire at Connector C, Pin 16.
2. Connect this wire to the ignition switch to allow the CenCom™ system to be turned off with the ignition switch. See Shutdown Module for optional connection

### Outputs

See page 10 for more information.

### Siren Speaker (Items 31 & 40)

1. Route the ORANGE and BROWN 16 gage wire (included) from Connector C, Pins 6 & 15, to the siren speaker.
2. Connect ORANGE wire to the WHITE speaker wire (speaker high).
3. Connect BROWN wire to BLACK speaker wire (speaker low).

*NOTE:* For dual speaker installation, connect the second speakers wires to the same destinations as the first speakers wires (see page 9).

### Radio Rebroadcast (Items 30 & 39)

Two (2) BLU wires are used to connect your two-way radio's external speaker for radio rebroadcast. This is an optional connection and will not effect the other operations. **Note:** Radio rebroadcast will **NOT** work with amplified remote speakers! If your remote speaker is amplified (i.e.: contains a power amp circuit in the speaker assembly), do not enable the radio rebroadcast feature.

1. Locate the two wires that connect the external speaker to the two-way radio, cut one of them and splice one of the BLU wires into this circuit.
2. Cut the remaining speaker wire and splice the remaining BLU wire into this circuit.

### Backlighting (Item 32)

*Note:* The CenCom backlight circuit has been designed to accept any of the following:

- 0 VDC input (off)
  - 12VDC input (on)
  - A Pulse Width Modulated (PWM) input with a range of 0% - 100% duty cycle @ 100Hz (i.e. dimmer circuit).
1. Route the WHT/BLK wire (included) from Connector C, Pin 7, to the vehicle's marker light circuit.
  2. Splice this wire into this circuit to enable the control head backlighting to be active whenever the vehicle's marker light is active.

### Programmable Inputs (Item 26, 27, 35, 36)

There are 4 programmable inputs in the CenCom system. The output signal line from devices such as a K-9 temperature sensor may be connected to these inputs. Two of these inputs (items 27 & 36) are designated for use when the Park-Kill or Hands-Free system options are used (see below).

### Park-Kill (Optional) (Item 27)

**CAUTION!** Always consult your vehicle's technical manual before altering your vehicle's wiring. Wiring modifications may compromise your vehicle's safety and/or performance. Use of the Park-Kill option may require the installation of the Whelen WPKM1 Park-Kill module. Consult your vehicle's technical manual before using this feature.

Using appropriately sized wire, extend and connect the WHT/ORN wire from Connector C, Pin 2, to the vehicle's transmission neutral safety switch signal wire. *NOTE:* For programming purposes, it is necessary to know whether this signal wire is switching the positive or negative side of the circuit.

### Hands-Free Siren (Items 36 & 38) (Optional)

1. Using a customer supplied relay capable of handling the current of your vehicle horn, connect as shown below.

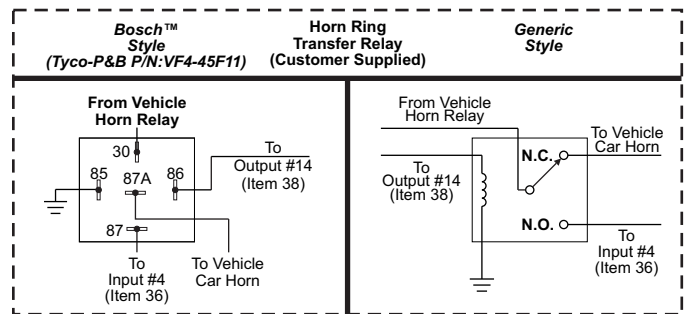

## PA Volume Adjustment

Locate the PA adjustment potentiometer on the right side of the CenCom module. Using a small, flat-blade screwdriver, set the potentiometer to its middle position. With the CenCom™ system on, activate the PTT (Push To Talk) feature on the optional microphone. Adjust the potentiometer until a satisfactory PA volume level is achieved using a normal speaking voice.

## Radio Repeat Volume Adjustment

To Adjust the Radio Repeat Levels: Before placing this unit into service, the Radio Repeat output volume must be adjusted to satisfactory operating levels. To adjust this level, a small, flat-blade screwdriver is needed. Locate the Radio Repeat adjustment potentiometer on the right side of the CenCom module. Set the volume of the vehicle's two-way radio to its normal operating level. Press the RAD button on the control head to activate Radio Repeat. As incoming transmissions are received, adjust the Radio Repeat potentiometer to set the desired level. Turn the potentiometer clockwise to increase the level and counter-clockwise to decrease the level.

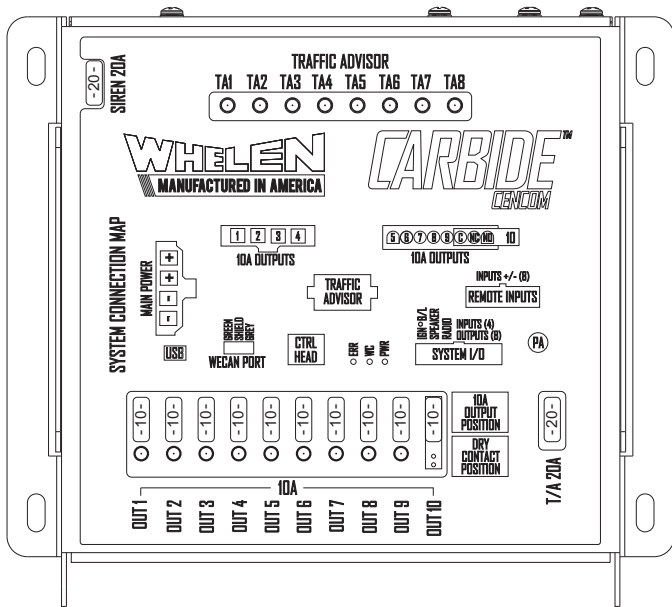

## Input Remote Module

The input remote module enables up to eight (8) non-CenCom vehicle components and/or equipment to be integrated into the CenCom/Carbine network.

As shown in the tables below, connect the input wire of the desired device to the appropriate wire. For example, if the device in question requires a Positive input signal, that input wire would be connected to the BROWN expansion module pigtail wire. In this example, that device would be recognized as "INPUT 5" by the CenCom/Carbine system. However, if that device requires a Negative input signal, that input wire would be connected to the WHT/BRN expansion module pigtail wire. Note that this device would be recognized as "INPUT 5" by the CenCom/Carbine system.

WIRE SIDE VIEW

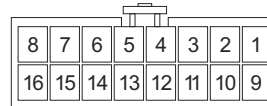

WIRE CHART

POS	COLOR	FUNCTION
1	BROWN	Positive Input 5
2	RED	Positive Input 6
3	ORANGE	Positive Input 7
4	YELLOW	Positive Input 8
5	GREEN	Positive Input 9
6	BLUE	Positive Input 10
7	VIOLET	Positive Input 11
8	GREY	Positive Input 12
9	WHT/BRN	Negative Input 5
10	WHT/RED	Negative Input 6
11	BWHT/ORG	Negative Input 7
12	WHT/YEL	Negative Input 8
13	WHT/GRN	Negative Input 9
14	WHT/BLU	Negative Input 10
15	WHT/VIO	Negative Input 11
16	WHT/GRY	Negative Input 12

## Control Heads....

A wide variety of control heads are available for use with this system. The specific function of any button, slide switch or rotary knob can be customized via the CenCom configuration software program.

## CenCom Module Fuses

For ease of access, all of the amp/relay module fuses are accessible from outside the case.

### Isolated Relay (Output 10)

The position of the Output 10 fuse determines the function of the Brown, Red and Orange wires. When the fuse is in Position 1, these wires act as a Isolated 10 Amp Relay. When the fuse is in Position 2, the Brown and Red wires act as Output #10. Refer to the schematic shown for the electronic properties of this circuit.

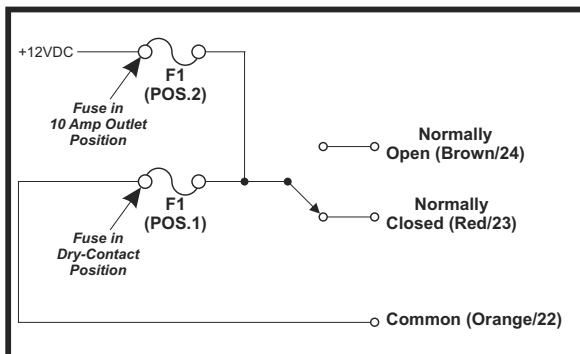

## LED Indicators

LED Indicators provide valuable information regarding the operational state of your CenCom system. There are 3 different sets of LED's for 3 different CenCom functions.

**Traffic Advisor Indicators** - These LEDs represent Traffic Advisor Output 1 (TA1) thru Traffic Advisor Output 8 (TA8). When a given output is active or flashing, the state of its corresponding indicator will be one of the following, based on the condition of that particular output:

On (steady) - Indicates the output is active and not flashing (normal).

On (flashing) - Indicates the output is active and flashing (normal).

Off - Indicates the output is shorted. Turn the CenCom system off, locate and remove the short. Restore power to the system and activate the output to confirm its proper operation.

**Output Indicators** - These represent Outputs 1 thru 9. Each indicator is located directly adjacent to the fuse for that output. When a given output is active, the state of its corresponding indicator will be one of the following, based on the condition of that particular output:

On - Indicates the output is active (normal).

Off - Indicates the output is shorted. Turn the CenCom system off, locate and remove the short. Replace the fuse for that output (with correct amperage rating) and restore power to the system. Activate the output to confirm its proper operation.

**WC Diagnostic Indicators** - These indicators provide the following diagnostic information about the CenCom system:

### ERR (Error) LED

Steady	CenCom Controller Bus is set to OFF. Check Interface Box.
Off	No Error
Single Flash	Bad CenCom connection. Check lightbar I/O or Interface Box for proper operation.
Double Flash	Error Control Event. Check lightbar I/O.

### WC (CenCom Serial Data Bus) LED

Steady	Good communication received from lightbar.
Off	Check power LED; If Off, turn on controller. If On, check connections.
Fast Blink	Pre-operational State (Boot-up)
Single Flash	Bad CenCom connection or CenCom off. Check lightbar I/O or interface box for proper operation.

### POW (Power) Status LED

Steady	CenCom system is On
Off	CenCom system is Off.

### USB Status LED

OFF	No connection detected.
Slow Flash	For factory purposes only.
Mom.Blink ON	Connection Detected / Not ready.
Mom.Blink OFF	Data Packet transferred.
Steady	Connection Detected / Ready for use.

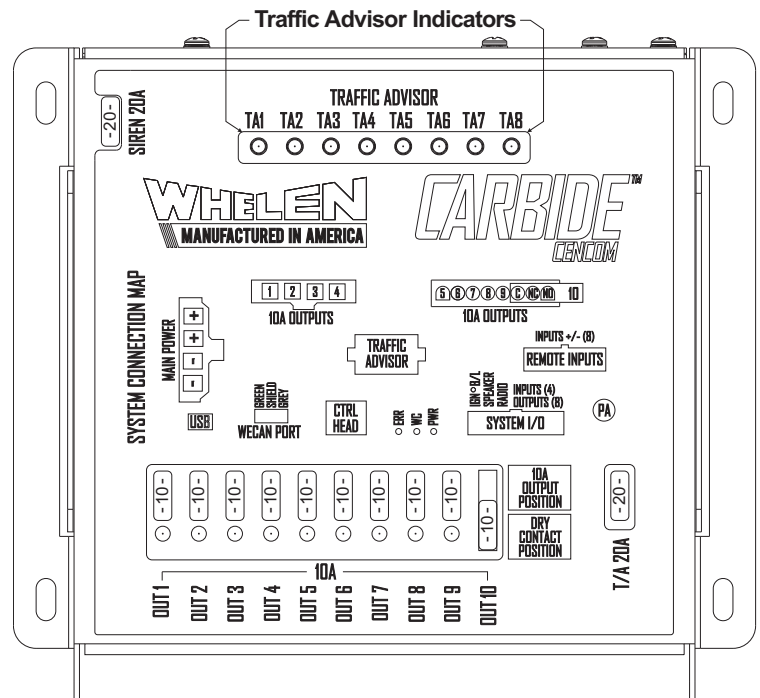



# CenCom™ Carbide System Wiring Guide

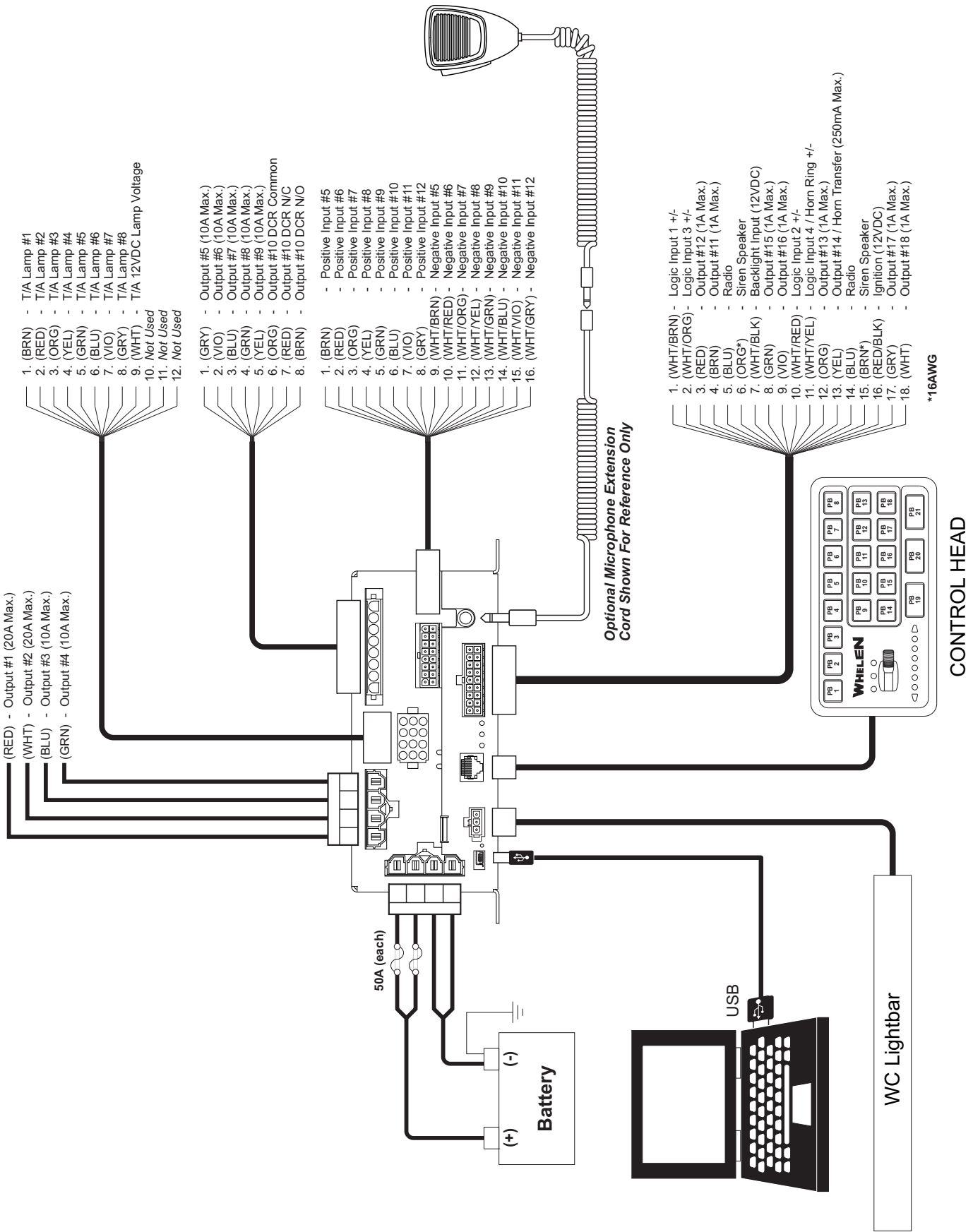

# CenCom™ Carbide Module Input/Output Identification

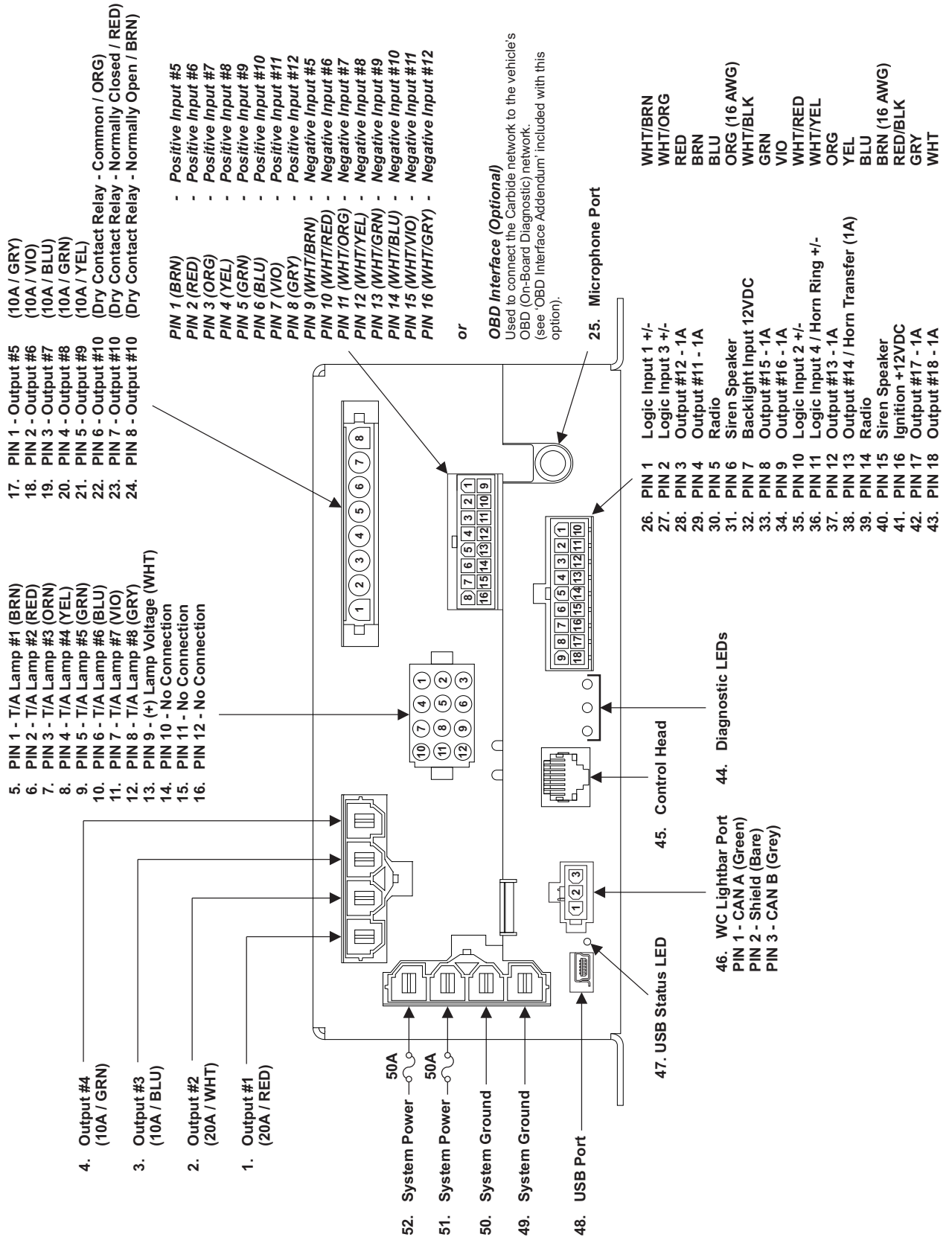

## Configuration Record:

For future reference, record the destination of each outlet and programmable input.

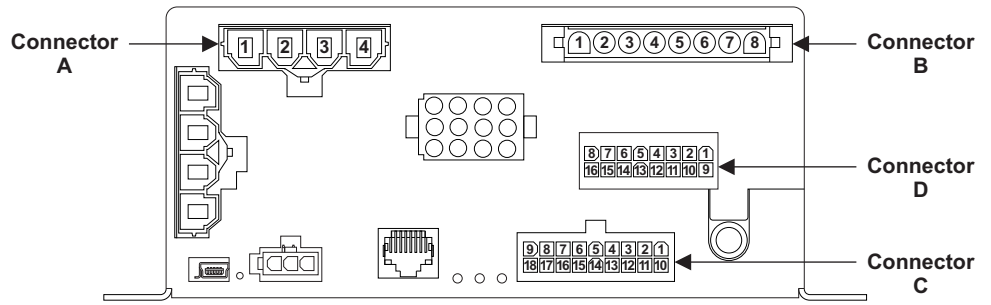

## Description:

## Assigned To:

## Connector / Pin #

Output #1 - 20 Amp (RED)	_____	Connector A / Pin #1
Output #2 - 20 Amp (WHT)	_____	Connector A / Pin #2
Output #3 - 10 Amp (BLU)	_____	Connector A / Pin #3
Output #4 - 10 Amp (GRN)	_____	Connector A / Pin #4
Output #5 - 10 Amp (GRY)	_____	Connector B / Pin #1
Output #6 - 10 Amp (VIO)	_____	Connector B / Pin #2
Output #7 - 10 Amp (BLU)	_____	Connector B / Pin #3
Output #8 - 10 Amp (GRN)	_____	Connector B / Pin #4
Output #9 - 10 Amp (YEL)	_____	Connector B / Pin #5
Output #10 - 10 Amp Dry Contact Relay: Common (ORG)	_____	Connector B / Pin #6
Output #10 - 10 Amp Dry Contact Relay: N/C (RED)	_____	Connector B / Pin #7
Output #10 - 10 Amp Dry Contact Relay: N/O (BRN)	_____	Connector B / Pin #8
Output #11 - 1 Amp (BRN)	_____	Connector C / Pin #4
Output #12 - 1 Amp (RED)	_____	Connector C / Pin #3
Output #13 - 1 Amp (ORN)	_____	Connector C / Pin #12
Output #14 - 1 Amp / Horn Relay (YEL)	_____	Connector C / Pin #13
Output #15 - 1 Amp (GRN)	_____	Connector C / Pin #8
Output #16 - 1 Amp (VIO)	_____	Connector C / Pin #9
Output #17 - 1 Amp (GRY)	_____	Connector C / Pin #17
Output #18 - 1 Amp (WHT)	_____	Connector C / Pin #18
Programable Input #1 (WHT/BRN)	_____	Connector C / Pin #1
Programable Input #2 (WHT/RED)	_____	Connector C / Pin #10
Programable Input #3 / Park Kill (WHT/ORN)	_____	Connector C / Pin #2
Programable Input #4 / Horn Ring (WHT/YEL)	_____	Connector C / Pin #11
Positive Input #5 - (BRN)	_____	Connector D / Pin #1
Negative Input #5 - (WHT/BRN)	_____	Connector D / Pin #9
Positive Input #6 - (RED)	_____	Connector D / Pin #2
Negative Input #6 - (WHT/RED)	_____	Connector D / Pin #10
Positive Input #7 - (ORN)	_____	Connector D / Pin #3
Negative Input #7 - (WHT/ORN)	_____	Connector D / Pin #11
Positive Input #8 - (YEL)	_____	Connector D / Pin #4
Negative Input #8 - (WHT/YEL)	_____	Connector D / Pin #12
Positive Input #9 - (GRN)	_____	Connector D / Pin #5
Negative Input #9 - (WHT/GRN)	_____	Connector D / Pin #13
Positive Input #10 - (BLU)	_____	Connector D / Pin #6
Negative Input #10 - (WHT/BLU)	_____	Connector D / Pin #14
Positive Input #11 - (VIO)	_____	Connector D / Pin #7
Negative Input #11 - (WHT/VIO)	_____	Connector D / Pin #15
Positive Input #12 - (GRY)	_____	Connector D / Pin #8
Negative Input #12 - (WHT/GRY)	_____	Connector D / Pin #16

# Wire Gauge Calculation Chart

## Maximum Current Draw Through The Wire

Wire Gauge	5 Amps	10 Amps	15 Amps	20 Amps	25 Amps	30 Amps	35 Amps	40 Amps	45 Amps	50 Amps
22 AWG	6 Feet	3 Feet	Insufficient	Insufficient	Insufficient	Insufficient	Insufficient	Insufficient	Insufficient	Insufficient
20 AWG	9.5 Feet	5 Feet	3 Feet	Insufficient	Insufficient	Insufficient	Insufficient	Insufficient	Insufficient	Insufficient
18 AWG	15 Feet	7.5 Feet	5 Feet	4 Feet	3 Feet	Insufficient	Insufficient	Insufficient	Insufficient	Insufficient
16 AWG	24.5 Feet	12 Feet	8 Feet	6 Feet	5 Feet	4 Feet	3.5 Feet	3 Feet	Insufficient	Insufficient
14 AWG	39 Feet	19.5 Feet	13 Feet	9.5 Feet	8 Feet	6.5 Feet	5.5 Feet	5 Feet	4.5 Feet	4 Feet
12 AWG	62 Feet	31 Feet	20.5 Feet	15.5 Feet	12.5 Feet	10.5 Feet	9 Feet	7.5 Feet	7 Feet	6 Feet
10 AWG	98 Feet	49 Feet	32.5 Feet	24.5 Feet	19.5 Feet	16.5 Feet	14 Feet	12.5 Feet	11 Feet	10 Feet
8 AWG	156 Feet	78 Feet	52 Feet	39 Feet	31 Feet	26 Feet	22.5 Feet	19.5 Feet	17.5 Feet	15.5 Feet
6 AWG	248.5 Feet	124 Feet	82.5 Feet	62 Feet	49.5 Feet	41.5 Feet	35.5 Feet	31 Feet	27.5 Feet	25 Feet
4 AWG	395 Feet	197.5 Feet	131 Feet	98.5 Feet	79 Feet	66 Feet	56.5 Feet	49.5 Feet	44 Feet	39.5 Feet
2 AWG	629 Feet	314 Feet	209 Feet	157 Feet	125.5 Feet	104.5 Feet	89.5 Feet	78.5 Feet	69.5 Feet	63 Feet

## Maximum Current Draw Through The Wire

Wire Gauge	55 Amps	60 Amps	65 Amps	70 Amps	75 Amps	80 Amps	85 Amps	90 Amps	95 Amps	100 Amps
22 AWG	Insufficient	Insufficient	Insufficient	Insufficient	Insufficient	Insufficient	Insufficient	Insufficient	Insufficient	Insufficient
20 AWG	Insufficient	Insufficient	Insufficient	Insufficient	Insufficient	Insufficient	Insufficient	Insufficient	Insufficient	Insufficient
18 AWG	Insufficient	Insufficient	Insufficient	Insufficient	Insufficient	Insufficient	Insufficient	Insufficient	Insufficient	Insufficient
16 AWG	Insufficient	Insufficient	Insufficient	Insufficient	Insufficient	Insufficient	Insufficient	Insufficient	Insufficient	Insufficient
14 AWG	3.5 Feet	3 Feet	3 Feet	3 Feet	Insufficient	Insufficient	Insufficient	Insufficient	Insufficient	Insufficient
12 AWG	5.5 Feet	5 Feet	5 Feet	4.5 Feet	4 Feet	4 Feet	3.5 Feet	3.5 Feet	3.5 Feet	3 Feet
10 AWG	9 Feet	8 Feet	7.5 Feet	7 Feet	6.5 Feet	6 Feet	6 Feet	5.5 Feet	5 Feet	5 Feet
8 AWG	14 Feet	13 Feet	12 Feet	11 Feet	10.5 Feet	10 Feet	9 Feet	8.5 Feet	8 Feet	8 Feet
6 AWG	22.5 Feet	20.5 Feet	19 Feet	17.5 Feet	16.5 Feet	15.5 Feet	14.5 Feet	14 Feet	13 Feet	12.5 Feet
4 AWG	36 Feet	33 Feet	30.5 Feet	28 Feet	26.5 Feet	24.5 Feet	23 Feet	22 Feet	21 Feet	19.5 Feet
2 AWG	57 Feet	52.5 Feet	48.5 Feet	45 Feet	42 Feet	39 Feet	37 Feet	35 Feet	33 Feet	31.5 Feet