

WHELEN[®]

ENGINEERING COMPANY INC.

51 Winthrop Road
Chester, Connecticut 06412-0684
Phone: (860) 526-9504
Fax: (860) 526-4078
Internet: www.whelen.com
Sales e-mail: autosale@whelen.com
Canadian Sales e-mail: canadiansales@whelen.com
Customer Service e-mail: custserv@whelen.com

Installation Guide: Model 295SDA2 Dual Siren Amplifier

DANGER! Sirens produce extremely loud emergency warning tones! Exposure to these tones without proper and adequate hearing protection, could cause ear damage and/or hearing loss! The Occupational Safety & Health Administration (www.osha.gov) provides information necessary to determine safe exposure times in Occupational Noise Exposure Section 1910.95. Until you have determined the safe exposure times for your specific application, operators and anyone else in the immediate vicinity should be required to wear an approved hearing protection device. **FAILURE TO FOLLOW THIS RECOMMENDATION COULD CAUSE HEARING LOSS!**

Warnings to Installers

Whelen's emergency vehicle warning devices must be properly mounted and wired in order to be effective and safe. Read and follow all of Whelen's written instructions when installing or using this device. Emergency vehicles are often operated under high speed stressful conditions which must be accounted for when installing all emergency warning devices. Controls should be placed within convenient reach of the operator so that they can operate the system without taking their eyes off the roadway. Emergency warning devices can require high electrical voltages and/or currents. Properly protect and use caution around live electrical connections. Grounding or shorting of electrical connections can cause high current arcing, which can cause personal injury and/or vehicle damage, including fire. Many electronic devices used in emergency vehicles can create or be affected by electromagnetic interference. Therefore, after installation of any electronic device it is necessary to test all electronic equipment simultaneously to insure that they operate free of interference from other components within the vehicle. Never power emergency warning equipment from the same circuit or share the same grounding circuit with radio communication equipment. All devices should be mounted in accordance with the manufacturer's instructions and securely fastened to vehicle elements of sufficient strength to withstand the forces applied to the device. Driver and/or passenger air bags (SRS) will affect the way equipment should be mounted. This device should be mounted by permanent installation and within the zones specified by the vehicle manufacturer, if any. Any device mounted in the deployment area of an air bag will damage or reduce the effectiveness of the air bag and may damage or dislodge the device. Installer must be sure that this device, its mounting hardware and electrical supply wiring does not interfere with the air bag or the SRS wiring or sensors. Mounting the unit inside the vehicle by a method other than permanent installation is not recommended as unit may become dislodged during swerving; sudden braking or collision. Failure to follow instructions can result in personal injury. Whelen assumes no liability for any loss resulting from the use of this warning device. **PROPER INSTALLATION COMBINED WITH OPERATOR TRAINING IN THE PROPER USE OF EMERGENCY WARNING DEVICES IS ESSENTIAL TO INSURE THE SAFETY OF EMERGENCY PERSONNEL AND THE PUBLIC.**

Warnings to Users

Whelen's emergency vehicle warning devices are intended to alert other operators and pedestrians to the presence and operation of emergency vehicles and personnel. However, the use of this or any other Whelen emergency warning device does not guarantee that you will have the right-of-way or that other drivers and pedestrians will properly heed an emergency warning signal. Never assume you have the right-of-way. It is your responsibility to proceed safely before entering an intersection, driving against traffic, responding at a high rate of speed, or walking on or around traffic lanes. Emergency vehicle warning devices should be tested on a daily basis to ensure that they operate properly. When in actual use, the operator must ensure that both visual and audible warnings are not blocked by vehicle components (i.e.: open trunks or compartment doors), people, vehicles, or other obstructions. It is the user's responsibility to understand and obey all laws regarding emergency warning devices. The user should be familiar with all applicable laws and regulations prior to the use of any emergency vehicle warning device. Whelen's audible warning devices are designed to project sound in a forward direction away from the vehicle occupants. However, because sustained periodic exposure to loud sounds can cause hearing loss, all audible warning devices should be installed and operated in accordance with the standards established by the National Fire Protection Association.

Safety First

This document provides all the necessary information to allow your Whelen product to be properly and safely installed. Before beginning the installation and/or operation of your new product, the installation technician and operator must read this manual completely. Important information is contained herein that could prevent serious injury or damage.

- Proper installation of this product requires the installer to have a good understanding of automotive electronics, systems and procedures.
- Whelen Engineering requires the use of waterproof butt splices and/or connectors if that connector could be exposed to moisture.
- Failure to use specified installation parts and/or hardware will void the product warranty.
- If mounting this product requires drilling holes, the installer **MUST** be sure that no vehicle components or other vital parts could be damaged by the drilling process. Check both sides of the mounting surface before drilling begins. Also de-burr the holes and remove any metal shards or remnants. Install grommets into all wire passage holes.
- If this manual states that this product may be mounted with suction cups, magnets, tape or Velcro®, clean the mounting surface with a 50/50 mix of isopropyl alcohol and water and dry thoroughly.
- Do not install this product or route any wires in the deployment area of your air bag. Equipment mounted or located in the air bag deployment area will damage or reduce the effectiveness of the air bag, or become a projectile that could cause serious personal injury or death. Refer to your vehicle owner's manual for the air bag deployment area. The User/Installer assumes full responsibility to determine proper mounting location, based on providing ultimate safety to all passengers inside the vehicle.
- For this product to operate at optimum efficiency, a good electrical connection to chassis ground must be made. The recommended procedure requires the product ground wire to be connected directly to the NEGATIVE (-) battery post (this does not include products that use cigar power cords).
- If this product uses a remote device for activation or control, make sure that this device is located in an area that allows both the vehicle and the device to be operated safely in any driving condition.
- It is recommended that these instructions be stored in a safe place and referred to when performing maintenance and/or reinstallation of this product.
- **FAILURE TO FOLLOW THESE SAFETY PRECAUTIONS AND INSTRUCTIONS COULD RESULT IN DAMAGE TO THE PRODUCT OR VEHICLE AND/OR SERIOUS INJURY TO YOU AND YOUR PASSENGERS!**

**ACTIVATION OF THIS
SIREN MAY DAMAGE
UNPROTECTED EARS!**



CAUTION
Loud siren noise can cause hearing damage and/or loss. Refer to OSHA Section 1910.95 prior to putting ANY siren into service!

Feature Summary:

Congratulations on selecting the 295SDA2 Dual Siren Control Center. This unit offers a unique collection of features designed to allow the user to customize the operation to suit their individual needs. Features include:

Siren:

- Two independent siren amplifiers that can drive one 100 watt siren speaker each.
- Non-destructive short circuit protection.
- Under/over voltage protection.
- Title 13 compliant tone set up.
- 20 programmable tones.
- Any combination of 2 tones can be programmed to any siren tone switch.

Installation:

Caution: Mounting will require drilling. It is absolutely necessary to make sure that no other vehicle components could be damaged in the process. Check both sides of the mounting surface before starting. If damage is likely, select a different mounting location.

Adjust RADIO or PA volume, using a flat blade screwdriver.

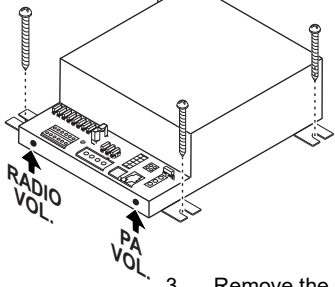

295SDA2 Module:

1. Find a mounting location. A dry, cool compartment is a good choice.
2. Position the unit on the proposed mounting location. Using an awl or similar tool, scribe the mounting surface where the mounting holes are to be drilled. Make sure that this mounting area allows sufficient ventilation for the unit.
3. Remove the unit and using a drill bit sized for a #10 sheet metal screw, drill a hole in each of the areas scribed in step 2.
4. Return the unit to its mounting location and using #10 x 3/4" sheet metal screws (provided), secure the unit onto its mounting surface. Be sure to install a #10 internal tooth lock washer (included) onto each mounting screw before mounting the unit. **IMPORTANT:** The module must be mounted on, or grounded to the vehicle chassis.

Hand-held Controller/Microphone

The system is controlled using a hand-held controller with a microphone (with Push-To-Talk key) and 12 illuminated push-buttons.

IMPORTANT: Do not remove the protective plastic from the control head until the installation is complete!

- Horn-ring transfer relay built in.
- Siren "in use" icon driver output.
- Siren disable (Park kill) control input.
- Includes Radio Repeat and PA.

Lighting control:

- 7 Programmable lighting control Switches.
- Three 20 Amp relay controlled outputs with built in fuses.
- Eight 10 Amp relay controlled outputs with built in fuses (two of them include a choice of independent inputs or the standard power bus switching).
- Two wire TrafficAdvisor™ control.
- Programming can not be activated by a user in the cab.

- All lighting switches can be programmed to activate any combination of relay outputs.
- All lighting switches can be programmed to activate or deactivate switches SW5 - SW8.
- Lighting switches can be programmed to be activated as either a *push-on / push-off, momentary, flashing, timed output TA control* or Alley (ALY) control.
- All lighting switches can be programmed to activate the siren into HF mode.
- Copy one units configuration to another unit, "CLONING".
- Reset to factory default settings.
- Change the "Shutdown Delay" time.
- Program the backlight intensity of the control head.

The mounting bracket for the controller should be located within a comfortable reaching distance from the operator.

Do not install this product or route any wires in the air bag deployment zone of your vehicle. Equipment mounted or located in air bag deployment zones will damage or reduce the effectiveness of the air bag, or become a projectile that could cause serious personal injury or death. Refer to your vehicle owner's manual to learn the air bag deployment zones for the vehicle. The User/Installer assumes full responsibility to determine proper mounting location, based on providing ultimate safety to all passengers inside the vehicle.

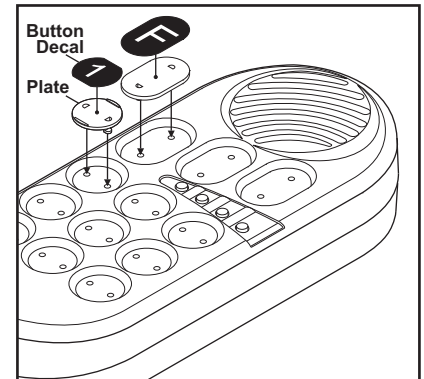
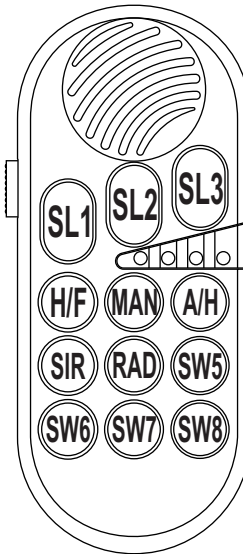

NOTE: The controller is shipped without any button decals installed. Do not place button decals directly onto the buttons. Install a plate onto each button first and then adhere the desired button decal onto that plate.

Wiring:

WARNING: All customer supplied wires that connect to the positive terminal of the battery must be sized to supply at least 125% of the maximum operating current and FUSED at the battery to carry that load. DO NOT USE CIRCUIT BREAKERS WITH THIS PRODUCT!

Siren Input (J7) - RED: Power - BLACK: Ground

1. Splice the 2 RED (Power) wires together, then extend this single RED wire toward the vehicle battery. Splice the 2 BLACK (Ground) wires together and extend this single BLACK wire toward the vehicle battery. To pass the RED and BLACK wires through, you may have to drill a hole in the firewall. Insert a grommet to protect the wires.
2. Route the RED and BLACK wires along the factory harness towards the battery and install a fuse block (user supplied) on the end of the RED wire. **Remove fuse from fuse block before connecting any wires to battery.**

3. Connect fuse block wire to POSITIVE terminal on battery. There must not be more than 2 feet of wire between fuse block and battery. The wire between the fuse and battery is "unprotected", do not allow it to chafe and short to ground. Connect the BLACK wire to the factory chassis ground.

Speaker (J6) - ORG, YEL, GRY & BRN

1. Route the ORG, YEL, GRY and BRN wires toward the vehicle siren speakers, along the factory wire harness and through the firewall at the same point as the RED and BLACK wires.
2. Connect the YELLOW wire to the POSITIVE terminal on SPEAKER #1 and the ORANGE wire to the POSITIVE terminal on SPEAKER #2. **NOTE: For single speaker installs use the YELLOW wire and cap the ORANGE wire.**
3. Connect BRN wire to NEGATIVE connection on speaker #1.
4. Connect GREY wire to NEGATIVE connection on speaker #2.

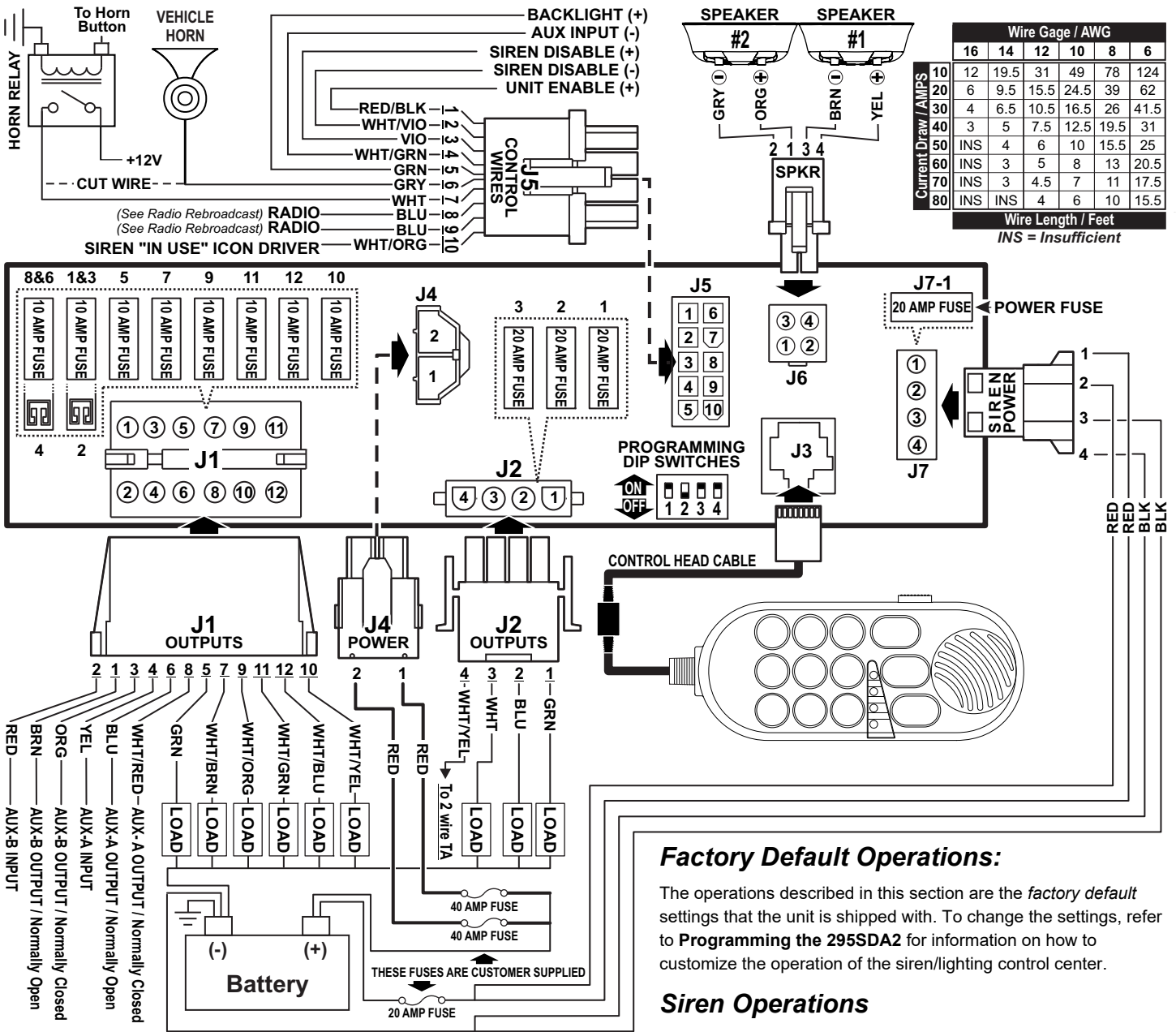

Factory Default Operations:

The operations described in this section are the *factory default* settings that the unit is shipped with. To change the settings, refer to **Programming the 295SDA2** for information on how to customize the operation of the siren/lighting control center.

Siren Operations

RAD - Radio Rebroadcast:

When this button is pressed, any signal that is received by the vehicle's two-way radio will be simultaneously broadcast over the vehicle's loudspeaker (the unit must be connected to the two-way radio as outlined in this manual). Pressing the RAD button again will deactivate it.

With the Radio Rebroadcast (RAD) button activated:

- Activating the A/H button will produce a higher frequency AIRHORN tone on speaker 1 and a Lower frequency AIRHORN tone on speaker 2 until released.
- Activating the SIR or H/F button will deactivate the RAD button and produce their corresponding function.
- Activating the HORN RING input will produce the cars horn until the HORN RING switch is released.
- Activating the SIREN DISABLE input has no effect.

SIR - Wail tone:

When this button is pressed, the siren will produce a synchronized Wail tone on both speakers. Pressing the SIR button again will deactivate it.

Horn Relay (J5) - WHITE & GREY

1. Route WHITE and GREY wires along factory wire harness and through the firewall at the same point as the RED and BLACK wires.
2. Route WHITE and GREY wires to vehicle's horn relay. If possible, follow the factory wire harness to this relay.
3. Cut the wire that connects the vehicle horn to the horn relay.
4. Connect the WHITE wire to the wire coming from the horn relay.
5. Connect the GREY wire to the wire coming from the horn.

Radio Rebroadcast (J5) (optional) - Two BLUE wires

The two BLUE wires are used to connect your two-way radio's external speaker for radio rebroadcast (optional connection).

Note: If your remote speaker is amplified (speaker has a power amp circuit), radio rebroadcast will not work and should not be used.

1. Locate the 2 wires that connect the external speaker to the 2-way radio, cut one and splice one of the BLUE wires into this circuit.
2. Cut the remaining speaker wire and splice the other BLUE wire into this circuit.

With the Siren (SIR) button activated:

- Activating the A/H button will produce a higher frequency AIRHORN tone on speaker 1 and a Lower frequency AIRHORN tone on speaker 2 until released.
- Activating the RAD or H/F button will deactivate the SIR button and produce their corresponding function.
- Activating the HORN RING input or MAN button will change the siren tone to two out of sync WAIL tones. Activating the HORN RING input or MAN button a second time returns it back to synchronized WAIL tones on both speakers
- Activating the SIREN DISABLE input will deactivate the SIR button.

H/F – Hands Free:

When you press H/F the siren functions are placed in a stand-by mode. Siren tones are activated by a single “tap” on the MAN button or the vehicle’s steering wheel horn ring (if the vehicle’s horn has been wired to the HORN RING input). The first tap produces two “Phased” Wail tones on both speakers. A second tap produces two “Phased” Yelp tones on both speakers. A third tap produces a Yelp tone on speaker 1 and a Piercer™ tone on speaker 2. The next tap returns the siren to the “Phased” Wail tones and the cycle repeats itself. Two quick successive taps stop the siren.

With the Hands Free (H/F) button activated:

- Activating the A/H button will produce a higher frequency AIRHORN tone on speaker 1 and a Lower frequency AIRHORN tone on speaker 2 until released.
- Activating the RAD or SIR button will deactivate the STANDBY button and produce their corresponding function.
- Activating the HORN RING input or MAN button will produce the hands free cycle as described above.
- Activating the SIREN DISABLE input will deactivate the H/F button.

MAN – Manual Wail:

When no other siren buttons are activated, pressing the MAN button generates two “Phased” Wail tones on both speakers that rises in pitch to a pre-set level. This tone is generated for as long as the Manual button is pressed. When the button is released the tone coasts down in frequency to a pre-set level and stops.

A/H – Airhorn tone:

- Activating the A/H button will always produce a higher frequency AIRHORN tone on speaker 1 and a Lower frequency AIRHORN tone on speaker 2 until released.

MICROPHONE – Public address:

- Activating the Push To Talk switch on the microphone will put speaker 1 in public address operation and will momentarily shut down any other siren function until the switch is released.

Lighting Control Operations:

Lighting Control Switches: The lighting control switches include switches SL1-3, and SW5-8 for a total of 7 lighting control switch positions. For each of the 7 switches there are corresponding relay controlled outputs on the connectors of J1 and J2 (see wiring diagram). The following list describes the Factory Default switch activated outputs.

Switch	Wire	Switch-Type	Other Actions
SL1.....	J2 pin 1 (GRN) J1 pin 10(WHT/YEL).....	Push on-Push off...	Stops HF cycle, deactivates SL2&3
SL2.....	J2 pin 1-2 (GRN,BLU) J1 pin 10 (WHT/YEL) J1 pin 12 (WHT/BLU)	Push on-Push off ...	Stops HF cycle, deactivates SL1&3
SL3.....	J2 pin 1-3 (GRN, BLU,WHT) J1 pin 10 (WHT/YEL) J1 pin 11 (WHT/GRN) pin 12 (WHT/BLU)	Push on-Push off...	Start HF cycle , deactivates SL1&2
SW5.....	J1 pin 7&9(WHT/ORG, WHT/BRN).....	“ALY cycle”.....	None
SW6.....	J1 pin 5(GRN).....	Push on-Push off.....	None
SW7.....	J1 pin 1(BRN).....	Push on-Push off.....	None
SW8.....	J1 pin 6(BLU).....	Momentary	None

Traffic Advisor Control

There are two programmable “Switch Types” associated with Traffic Advisor control, “Traffic Advisor Pattern Control” and “Traffic Advisor Flash Control”.

When a switch’s “Switch Type” has been programmed as “Traffic Advisor Pattern Control”, this switch now takes control of designated Traffic Advisor output J2 pin 4 (white yellow) and the associated relay output of the programmed switch. These two wires connect to the traffic advisor.

The first press of this switch will produce a Left sweep on the Traffic Advisor, and will turn off a “Traffic Advisor Flash Control” switch if one is active.

A second press will produce a right arrow.

A third press will produce a split arrow.

The next press returns the unit to Left arrow and the cycle repeats itself. Holding the switch down for 2 seconds will shut the arrow off.

NOTE: Only one switch can be programmed as a “Traffic Advisor Pattern Control” switch, if more than one switch is programmed, unpredictable results will occur.

When a switch’s “Switch Type” is programmed as “Traffic Advisor Flash Control”:

Pressing this switch will produce a flash pattern on the Traffic Advisor indicator, will turn off a “Traffic Advisor Pattern Control” switch if one is active, and the relay output programmed for the “Traffic Advisor Flash Control” switch will turn on.

Pressing this switch again will shut the arrow off.

NOTE: Only one switch can be designated as a “Traffic Advisor Flash Control” switch, if more than one switch is programmed, unpredictable results will occur.

Alley Cycle (ALY)

Switch SW5 on the control head is set up to operate the Alley cycle, and controls outlets J1 pin 7 and pin 9 on the amplifier, and is intended to control the Alley lights on a lightbar. The outputs are controlled as follows:

1st Press - Activates J1 pin 9, WHT/ORG (Left alley).

2nd Press - Deactivates J1 pin 9, WHT/ORG & Activates J1 pin 7, WHT/BRN (Right alley).

3rd Press - Activates J1 pin 9, WHT/ORG & J1 pin 7, WHT/BRN (Left & Right alleys).

4th Press - Deactivates J1 pin 9, WHT/ORG & J1 pin 7, WHT/BRN (Alleys off).

Terminal Operation

Terminal Specifications

NOTE: It is important that any components connected to these terminals do not exceed the maximum current rating for that terminal.

Warning! Total power distribution current is not to exceed 80 AMPS.

Outlet	Max. Load	J1-11	10 Amps
J2-1	20 Amps	J1-12	10 Amps
J2-2	20 Amps	J1-1 & J1-3 or J1-2	10 Amps
J2-3	20 Amps	(Outlets can not be activated simul-	taneously)
J1-5	10 Amps	J1-8 & J1-6 or J1-4	10 Amps
J1-7	10 Amps	(Outlets can not be activated simul-	taneously)
J1-9	10 Amps		
J1-10	10 Amps		

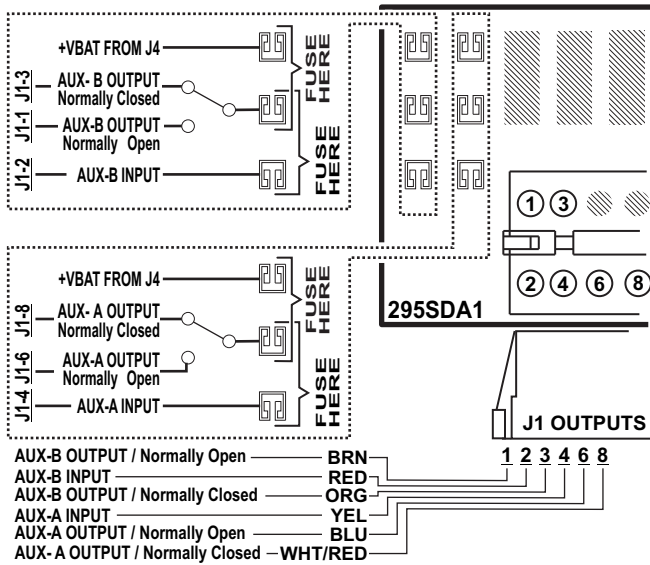

Dip Switch Settings

SW1	SW2	SW3	SW4	Operation
ON	OFF	ON	ON	Normal operations
ON	OFF	ON	OFF	Programming lighting
OFF	OFF	ON	ON	Programming Siren tones

Any other Dip Switch setting combinations are not valid and are not recommended.

Programming the 295SDA2:

WARNING: Never try to program the unit while it is wired to the vehicle. The unit must be removed from the vehicle before programming. For programming, connect positive (+) 12 volts and ground to J7, and pin 1 of J5 to (+) 12 volts only.

Programming the 295SDA2:

The 295SDA2 has the ability to program both the siren switches and the lighting control switches via the keypad of the control head.

The 295SDA2 programmable switches include 7 lighting control switches (SL1, SL2, SL3, SW5, SW6, SW7, SW8) and 5 siren control switches (H/F, MAN, A/H, SIR, Rad). For each of the lighting control switches there are corresponding relay outputs.

The 295SDA2 has the capability of customizing how the lighting control switches operate, and how they control the relay outputs as well as siren enable. Lighting control switches SW5, 6, 7 and 8 can be configured to operate in one of seven switch types: push on push off, momentary, flashing, timed output, TA pattern control, TA flash control or 'Aly cycle'.

Any of the lighting control switches can be programmed to activate any combination of relay outputs. Any of the lighting control switches can be configured to remotely activate or deactivate any other lighting control switches. Any of the lighting control switches can be configured to activate the siren into the HF mode. One units programmed configuration can be copied to another unit, and factory defaults can be restored.

Any tone can be programmed into any active siren control location. Title 13 Operation (and a set of title 13 tones) can be programmed as well as Ignition Shutdown Delay and Indicator or Backlight intensity. The following sections describe how to program the 295SDA2.

Programming the lighting control operations:

Put the unit into "Lighting control programming mode" by placing DIP switch 1&3 into the ON position and DIP switch 2&4 in the OFF position (See wiring diagram). With the DIP switches in this position siren functions are disabled, leaving the lighting functions and lighting programming active.

(1) Switch Type Programming:

Lighting control switches SW5, 6, 7 and 8 can be configured to operate as one of seven types. The types are: Push On Push Off, Momentary, Flashing Output (60 FPM), Timed Output (10 seconds), TA pattern control, TA flash, or 'Aly cycle'. Factory Default: SW5 = 'Aly cycle', SW6,7 = push on-push off SW8 = Momentary (DIP SWITCH SETTING: SWITCHES 1 & 3 ON / SWITCHES 2&4 OFF)

To Configure a switch's "Switch Type":

1. Put the unit into "Switch Type" configuration Mode:

Turn all switches off.

- Press and hold the RAD switch.
- Press and release momentary switch SL1.
- Release the RAD switch.

To confirm entry into this configuration mode, LED 4 on the Arrow indicator will light up.

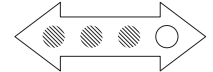

2. Select a switch to be configured:

- Press and release the switch that you wish to configure.

The selected switch's light will turn on steady. The slide switch indicator lights will light up indicating the type of switch that is currently configured (table 2).

3. Choose a "Switch Type" for the selected switch:

- Press and release the AIRHORN switch to cycle through the switch type choices in table 2.
- Stop when the indicator lights match the desired switch type.

Table 2

①	②	③	Slide Switch Indicators
●	●	●	Push On Push Off
○	●	●	Momentary
●	○	●	Timed Output
○	○	●	Flashing Output
●	●	○	TA Pattern Control
●	○	○	TA Flash Control
○	○	○	Aly cycle

● = OFF ○ = ON

4. Store and activate the switch's "Switch Type":

Press and release the RAD switch.

All of the indicator lights will turn off and the data will be stored. This will put the unit back into lighting operating mode, and this change can be tested. To configure another switch start back at step 1.

(2) Relay Output Programming:

Any of the lighting control switches can be configured to activate any combination of the relay outputs.

DIP SWITCH SETTING: SWITCHES 1 & 3 ON / SWITCHES 2 & 4 OFF

To Configure a switch's relay outputs:

1. Put the unit into "Relay Output" configuration mode:

Turn all Momentary switches off.

- Press and hold the RAD switch.
- Press and release momentary switch SL2.
- Release the RAD switch.

To confirm entry into this configuration mode, LED 3 on the Arrow indicator will light up.



2. Select a switch to be configured:

Press and release the switch that you wish to configure.

All switch indicator lights whose corresponding relay output is already in the selected switch's configuration will turn on steady.

3. Add or delete relay outputs activated by the switch:

- Press and release one of the switches to add or delete its corresponding output. This switches indicator light will turn on steady when its corresponding output is selected to be activated.

Outputs J1 pin 10(WHT/YEL), J1 pin 12(WHT/BLU) and J1 pin 11(WHT/GRN) can be added or deleted by using switches H/F, MAN and A/H respectfully.

4. Store and activate the switch's relay output pattern:

Press and release the RAD switch.

All indicator lights will turn off and the data will be stored. This will put the unit back into lighting operating mode, and this change can be tested. To configure another switch start back at step 1.

(3) Re-Setting Factory Defaults

(lighting and siren operation):

(DIP SWITCH SETTING: SWITCHES 1 & 3 ON / SWITCHES 2 & 4 OFF)

To restore the factory defaults:

Turn all switches off.

- Press and hold the RAD switch.
- Press and release momentary switch SL3.
- Release the RAD switch.

To confirm that the factory defaults have been restored, LED 2 on the Arrow indicator will light up for two seconds.

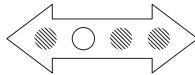

After the 2 seconds pass, all of the indicator lights will turn off and the factory defaults will be stored. This will put the unit back into lighting operating mode, and the lighting defaults can be tested.

NOTE: The siren defaults cannot be tested until the unit is out of programming mode (i.e. dip switches 1, 3 & 4 ON, 2 OFF)

(4) Activating the Siren:

Any of the lighting control switches can be configured to activate the siren into the HF mode.

Factory Default: Switch SL3

To activate the siren from a lighting switch:

(DIP SWITCH SETTING: SWITCHES 1 & 3 ON / SWITCHES 2 & 4 OFF)

1. Put the unit into "Siren Activation" mode:

- Turn all switches off.
- Press and hold the SIR switch.
- Press and release switch SW7.
- Release the SIR switch.

To confirm entry into this configuration mode, LED 2 & 4 on the Arrow indicator will light up.

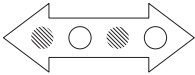

AND...

All switch indicator lights whose corresponding switch is already programmed to activate the Siren will turn on steady.

2. Add or Delete switches:

To select a switch:

- Press and release one of the lighting switches to add or delete it from activating the siren. The switches indicator light will turn on steady when its corresponding switch is selected.

3. Store and activate the selected switch's:

- Press and release the SIR switch.

All of the indicator lights will turn off and the data will be stored. This will put the unit back into lighting operating mode.

NOTE: This change cannot be tested until the unit is out of programming mode (i.e. dip switches 1, 3 & 4 ON, 2 OFF)

(5) Deactivating the Siren:

Any of the lighting control switches can be configured to deactivate the siren out of H/F mode.

Factory Default: Switches SL1 and SL2

To deactivate the siren from a lighting switch:

(DIP SWITCH SETTING: SWITCHES 1 & 3 ON / SWITCHES 2 & 4 OFF)

1. Put the unit into "Siren Deactivation" mode:

Turn all switches off.

- Press and hold the SIR switch.
- Press and release switch SW8.
- Release the SIR switch.

To confirm entry into this configuration mode, LED 1 and 4 on the Arrow indicator will light up.

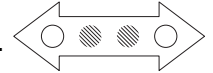

AND...

All switch indicator lights whose corresponding switch is already programmed to deactivate the Siren will turn on steady.

2. Add or Delete switches:

To select a switch:

- Press and release one of the lighting switches to add or delete it from deactivating the siren. The switches indicator light will turn on steady when its corresponding switch is selected.

3. Store and activate the selected switch's:

- Press and release the SIR switch.

All of the indicator lights will turn off and the data will be stored. This will put the unit back into lighting operating mode.

NOTE "A": This change cannot be tested until the unit is out of programming mode (i.e. dip switches 1, 3 & 4 ON, 2 OFF)

(6) Remote Activation of the switches:

Any of the lighting control switches can be configured to remotely activate any of the other lighting control switches.

Factory Default: No momentary switches are remotely activated.

(DIP SWITCH SETTING: SWITCHES 1 & 3 ON / SWITCHES 2 & 4 OFF)

To activate Lighting Control Switches:

1. Put the unit into Switch Activation Mode:

- Turn all switches off.
- Press and hold the H/F switch.
- Press and release switch SL2.
- Release the H/F switch.

To confirm entry into this configuration mode, LED 2 & 3 on the Arrow indicator will light up.

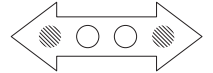

2. Select a switch to be configured:

- Press and release the switch that you wish to configure.

All switch indicator lights whose corresponding switch is already programmed to be activated by the selected switch will turn on steady.

3. Add or delete switches activated by the selected switch:

- Press and release one of the lighting switches to add or delete it from the selected switch's configuration. The switch's indicator light will turn on steady when its corresponding switch is selected to be activated.

4. Store and activate the selected switch's configuration:

- Press and release the H/F switch.

All of the indicator lights will turn off and the data will be stored. This will put the unit back into lighting operating mode, and this change can be tested. To configure another switch start back at step 1.

(7) Remote Deactivation of the switches:

Any of the lighting control switches can be configured to remotely deactivate any of the other lighting control switches.

Factory Default: SL1 deactivates SL2&3, SL2 deactivates SL1&3, SL3 deactivates SL1&2

(DIP SWITCH SETTING: SWITCH 1, 2 & 3 ON / SWITCH 4 OFF)

To deactivate Lighting Control Switches:

1. Put the unit into Switch Deactivation Mode:

- Turn all switches off.
- Press and hold the H/F switch.
- Press and release switch SL1.
- Release the H/F switch.

To confirm entry into this configuration mode, LEDs 3 & 4 on the Arrow indicator will light up.

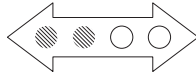

2. Select a switch to be configured:

Press and release the switch that you wish to configure.

All switch indicator lights whose corresponding switch is already configured to be deactivated by the selected Switch will turn on steady

1. Add or delete switches deactivated by the selected switch:

- Press and release one of the lighting switches to add or delete it from the selected switch's configuration. The switch's indicator light will turn on steady when its corresponding switch is selected to be deactivated.

2. Store and activate the selected switch's configuration:

- Press and release the H/F switch.

All of the indicator lights will turn off and the data will be stored. This will put the unit back into lighting operating mode, and this change can be tested. To configure another switch, start back at step 1.

(8) Copying a units configuration:

If there is more than one unit that needs to be configured to operate in the same manor, it is not necessary to configure each unit separately. Once one unit has been configured to operate as desired, it can be used as the "primary" unit and its configuration can be copied to another unit that is set up as a "secondary" unit.

To copy a configuration to a second unit:

(DIP SWITCH SETTING: SWITCH 1 & 3 ON / SWITCHES 2 & 4 OFF)

1. Wire the units as follows:

- Connect J7 on both units to a common power source (PIN1 to (+)V BAT & PIN 4 to Ground).
- Connect pin 10 of J5 on the "primary" unit to pin 5 of J5 on the "secondary" unit.
- Connect pin 1 of J5 of both units to (+)V BAT, Leave all other wiring unconnected.

2. Put the "PRIMARY" unit into "transmit" mode:

- Turn all switches off.
- Press and hold the RAD switch.
- Press and release switch SW7.
- Release the RAD switch.

To confirm entry into "transmit" mode, LED 1 on the Arrow indicator will light up.



3. Put the "SECONDARY" unit into "receive" mode:

- Turn all switches off.
- Press and hold the RAD switch.
- Press and release SWITCH SW6.
- Release the RAD switch.

To confirm entry into "receive" mode, LEDs 2, 3 and 4 on the Arrow indicator will light up.



4. Transfer the Configuration:

- Watch the 3 slide switch indicators on the "SECONDARY" unit, when the left most indicator turns on, proper communications have been established.
- Press and release switch SL1 on the "primary" unit to start the transfer.
- On the "PRIMARY" unit see that the right most indicator on the arrow turns on to indicate that the transfer has been started.
- Watch the 3 slide switch indicators on the "SECONDARY" unit, in 5 seconds the middle indicator turns on and transfer is complete.

NOTE: If the SL3 indicator light on the "secondary" unit turns on, an error has occurred. Press the RAD on both units to go back to step 1.

5. Store and activate the configuration:

- Press and release the RAD switch on both the "primary and secondary" units.

All of the indicator lights will turn off and the data will be stored. This will put both units back into lighting operating mode.

OR...

- Turn the power off on both the "primary and secondary" units.

To transfer the configuration to another unit start back at step 1.

(9) Changing between standard and Title 13 operation:

When in title 13 operation, the airhorn tone will override the primary siren tone on only one of the siren speakers, in standard operation, the airhorn tone will override the primary siren tone on both of the siren speakers.

Factory Default: standard operation.

(DIP SWITCH SETTING: SWITCHES 1 & 3 ON / SWITCHES 2 & 4 OFF)

To change between standard and Title 13 operation:

- Turn all switches off.
- Press and hold the SIR switch.
- Press and release switch SL1.
- Release the SIR switch.

To confirm that the unit is in title 13 operation, LEDs 1, 2 and 3 on the Arrow indicator will light up for two seconds.

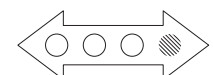

To confirm that the unit is in standard operation, LEDs 1 and 3 on the Arrow indicator will light up for two seconds.

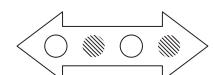

All of the indicator lights will turn off and the operation change will be stored. This will put the unit back into lighting operating mode.

NOTE: The siren operations cannot be tested until the unit is out of programming mode (i.e. Dip switches 1, 3 & 4 ON / 2 OFF.)

(10) Programming a tone set of Title 13 tones:

This procedure will program the unit with a default set of tones that will meet title 13 requirements, and will change the unit to operate under title 13 guidelines as described in Section (9).

(DIP SWITCH SETTING: SWITCH 1 & 3 ON / SWITCHES 2 & 4 OFF)

Programming a tone set of Title 13 tones:

- Turn all switches off.
- Press and hold the SIR switch.
- Press and release switch SL2.
- Release the SIR switch.

To confirm that the title 13 defaults have been set, LEDs 1, 3 and 4 on the Arrow indicator will light up for two seconds.

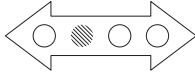

All of the indicator lights will turn off and the title 13 defaults will be stored. This will put the unit back into lighting operating mode.

NOTE: The siren cannot be tested until the unit is out of programming mode (i.e. dip switches 1, 3 & 4 ON / 2 OFF)

(11) Changing Red indicator intensity:

This procedure will allow adjustments to be made of the intensity of the red indicator LEDs on the control head.

Factory Default: 50%.

To adjust the red LED indicator:

(DIP SWITCH SETTING: SWITCH 1 & 3 ON / SWITCH 2 & 4 OFF)

1. Put the unit into "indicator adjustment" Mode:

- Turn all switches off.
- Press and hold the SIR switch.
- Press and release switch SL3.
- Release the SIR switch.

To confirm that the unit is in title 13 operation, LEDs 1 and 2 on the Arrow indicator will light up for two seconds.

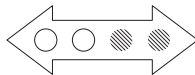

2. To make them brighter:

- Press and release the MAN switch until the desired intensity has been met.

OR...

To make them dimmer:

- Press and release the A/H switch until the desired intensity has been met.

3. Store and activate the indicator intensity.

- Press and release the SIR switch.

All of the indicator lights will turn off and the indicator intensity will be stored. This will put the unit back into lighting operating mode.

(12) Changing Backlight intensity:

This procedure will allow adjustments to be made of the intensity of the backlight LEDs on the control head.

Factory Default: 50%. To adjust the backlight:

(DIP SWITCH SETTING: SWITCHES 1 & 3 ON / SWITCHES 2 & 4 OFF)

1. Put the unit into "backlight adjustment" Mode:

- Turn all switches off.
- Connect J5 PIN 5 to +VBAT (To turn on the backlight).
- Press and hold the H/F switch.
- Press and release switch SL3.
- Release the H/F switch.

To confirm entry into "backlight adjustment" mode, all LEDs on the Arrow indicator will light up.



2. To make them brighter:

Press and release the MAN switch until the desired intensity is met.

OR...

To make them dimmer:

- Press and release the A/H switch until the desired intensity is displayed.

3. Store and activate the backlight intensity.

- Press and release the H/F switch.

All of the indicator lights will turn off and the backlight intensity will be stored. This will put the unit back into lighting operating mode.

(13) Changing Shutdown Delay:

This procedure will allow adjustments to the time that the unit will operate after the UNIT ENABLE input becomes inactive.

Factory Default: OFF immediately

To adjust the Shutdown Delay:

(DIP SWITCH SETTING: SWITCHES 1 & 3 ON / SWITCHES 2 & 4 OFF)

1. Put the unit into "Shutdown Delay adjustment" Mode:

- Turn all switches off.
- Press and hold the RAD switch.
- Press and release switch SW8.
- Release the RAD switch.

To confirm entry into "Shutdown Delay adjustment" mode, the Arrow indicator will display this pattern: (arrow leds 1, 2 & 4)

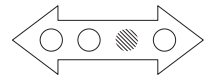

2. To adjust the time of operation

- Press and release the A/H switch to cycle through time choices until the desired time has been met (table 3)

3. Store and activate the time of operation.

- Press and release the RAD switch.

All of the indicator lights will turn off and the shutdown delay will be stored. This will put the unit back into lighting operating mode.

Table 2

①	②	③	Slide Switch Indicators
●	●	●	Push On Push Off
○	●	●	Momentary
●	○	●	Timed Output
○	○	●	Flashing Output
●	●	○	TA Pattern Control
○	●	○	TA Flash Control
●	●	○	Aly cycle
●	○	○	

● = OFF ○ = ON

(14) Changing Siren Disable operation:

Siren disable can be configured to operate in one of two ways:

CANCEL: When one of the SIREN DISABLE inputs (see wiring diagram) becomes active the siren tones will deactivate, but siren tones can be reactivated manually through the control head while the SIREN DISABLE input is still active.

PAUSE Operation: When one of the SIREN DISABLE inputs (see wiring diagram) becomes active the siren tones will deactivate and siren tones will become reactivated when the SIREN DISABLE input becomes inactive.

Factory Default: CANCEL Operation.

(DIP SWITCH SETTING: SWITCHES 1 & 3 ON / SWITCHES 2 & 4 OFF)

To change between standard and Alternate Operation:

- Turn all switches off.
- Press and hold the SIR switch.
- Press and release switch SW6.
- Release the SIR switch.

To confirm that the unit is in PAUSE Operation LEDs 1, 2 and 3 on the Arrow indicator will light up for two seconds.

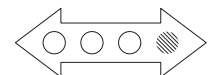

To confirm that the unit is in CANCEL Operation, LEDs 1, 2 and 3 on the Arrow indicator and the MAN button will light up for two seconds.



After two seconds all of the indicator lights will turn off and the operation change will be stored. This will put the unit back into programming mode.

NOTE: The siren operations cannot be tested until the unit is out of programming mode (i.e. dip switches 1, 3 & 4 ON / 2 OFF)

Programming Siren tones:

DIP SWITCH SETTING: Put the unit into “tone programming mode” by placing DIP switch 1 and 2 into the **OFF** position and DIP switch 3 and 4 in the **ON** position (see wiring for DIP switch location). With the DIP switches in this position lighting functions are disabled, leaving the siren functions and tone programming active.

To change the primary tone for Siren (SIR) switch position:

- Activate the Siren (SIR) switch.
- Press and release SL1.

OR...

- Press and release switch SL2 to change the tone produced by speaker 2.
- Each time a switch is pressed and released, the next available tone will be broadcast on the corresponding speaker.

AND...

- The other speaker will shut off for 2 seconds so that the new tone can be clearly identified.
- When the desired tone is generated, it is automatically saved in that switch position for that speaker.

To change the override tone for the SIR switch position:

- Activate the switch position that you wish to change.
- Activate the SIR switch.
- Press and release the MAN switch to produce it's override tone
- Press and release SL1 to change the tone produced by speaker 1.

OR...

- Press and release SL2 to change the tone produced by speaker 2.
- Each time a switch is pressed and released, the next available tone will be broadcast on the corresponding speaker.

AND...

- The other speaker will shut off for 2 seconds so that the new tone can be clearly identified.
- When the desired tone is generated, it is automatically saved as the override tone in that switch position for that speaker.

Tone list for Wail, Yelp & Tone 3 buttons and their override tones, and all hf positions:

• Tone off	• Phased Yelp	• Mechanical	• Woop
• Wail	• Yelp 2	• Phased Mechanical	• Phased Woop
• Phased wail	• Yelp 249	• Mechanical 2	• Wail Yelp combo
• Wail 2	• Piercer	• Warble	• Wail Yelp Combo 2
• Yelp	• Hilo	• Phased Warble	• Wail Yelp Y429 Piercer Combo

To change the tones in a HANDS FREE cycle position (STANDBY switch):

- Activate the H/F switch.
- Press and release the MAN switch to advance to the HAND FREE cycle position that you want to change.
- Press and release SL1 to change the tone produced by speaker 1.

OR...

- Press and release SL2 to change the tone produced by speaker 2.
- Each time a switch is pressed and released, the next available tone will be broadcast on the corresponding speaker.

AND...

- The other speaker will shut off for 2 seconds so that the new tone can be clearly identified.
- When the desired tone is generated, it is automatically saved for that HAND FREE cycle position for that speaker.

Tone list for the MANUAL button:

• Wail coast	• Phased Wail Stop	• Mechanical stop
• Phased Wail coast	• Mechanical coast	• Phased Mechanical stop
• Wail Stop	• Phased Mechanical coast	

To change the tone for the MAN and A/H switch:

- Press and hold the MAN or A/H switch.
- Press and release SL1 to change the tone produced by speaker 1.

OR...

- Press and release SL2 to change the tone produced by speaker 2.
- Each time a switch is pressed and released, the next available tone will be broadcast on the corresponding speaker.

AND...

- The other speaker will shut off for 2 seconds so that the new tone can be clearly identified.
- When the desired tone is generated, it is automatically saved for the chosen switch for that speaker.

Tone List for Airhorn button:

• Tone off
• Airhorn
• Airhorn low

Diagnostic Indicators:

While the siren is under normal use the diagnostic indicators are used to indicate fault conditions within your siren system. The following table lists the type of fault and the indicators response.

Over voltage: The left most LED on the arrow will be in DoubleFlash mode and siren tones will not operate.

Speaker # 1 short circuit: The left most LED on the arrow will be in SingleFlash mode and siren tones will not operate on speaker 1.

Speaker # 2 short circuit: The right most LED on the arrow will be in SingleFlash mode and siren tones will not operate on speaker 2.

DoubleFlash: 2 quick flashes followed by a longer pause.

SingleFlash: LED will be on and off an equal amount of time.