

WHELEN[®]

ENGINEERING COMPANY INC.

51 Winthrop Road
 Chester, Connecticut 06412-0684
 Phone: (860) 526-9504
 Fax: (860) 526-2009
 Internet: www.whelen.com
 Sales/Service e-mail: aviation@whelen.com

Installation Guide: Model 9072418, 9072419 P/N:01-0790724-18 01-0790724-19 LED Anti-Collision Light Assembly

TSO-C96a
 CLASS III;
 APPROVED



The conditions and tests required for TSO approval of this article are minimum performance standards. It is the responsibility of those installing this article either on or within a specific type or class of aircraft to determine that the aircraft installation conditions are within the TSO standards. TSO articles must have separate approval for installation in aircraft. The article may be installed only if performed under 14 CFR part 43 or the applicable airworthiness requirements.

OPERATING INSTRUCTIONS:

Operational Voltage: 28 VDC
 (Operation from 22-32 VDC)
Average Input Current: 0.3 Amps
Pulse : 1.6 Amps
Flashrate: 45± 5 FPM
Weight: 2.0 Lbs.

EQUIPMENT LIMITATIONS: An approved Anti-Collision light assembly should be located so that their light will not impair the crews vision or detract from the conspicuity of the position lights. The baseplate must be mounted parallel to the vertical and horizontal centerlines of the aircraft to project the patterns properly. Certain types of aircraft may require additional testing.

CONTINUED AIRWORTHINESS: The LED anti-collision light assembly is designed with 6 vertical columns consisting of 6 LEDs each. Should any one LED fail, the unit must be repaired or replaced. **Note:** To reduce eye strain use an optical filter such as dark glasses or a blue covering dome during LED inspection. Inspect the lens and replace if there is excessive scratching, pitting, discoloration or cracking.

INSTALLATION PROCEDURES: The following information is to assist in the installation of a Whelen LED Anti-collision Light System.

- Using the mounting detail information provided, prepare the aircraft for means to secure the LED Light assembly.
- Connect the light inputs according to the chart shown. Connect the power lead to an appropriately sized breaker. Connections to be in accordance with FAA approved methods.
- Carefully remove the Phillips screws, retainer and lens. **CAUTION:** Do not touch the LED with either fingers or sharp objects. This could soil and/or damage the lens and effect the optical performance of the LEDs.
- Using the appropriate hardware install the baseplate gasket and light assembly to the aircraft. Insure that all leads are clear of any obstructions and secured as required. **IMPORTANT!** Be sure that the light assembly drain hole is not obstructed (see artwork).
- Reinstall gasket, lens and retainer. Confirm proper gasket fit. Reinsert screws and tighten firmly.
- Check all avionics systems for interference from this installation.
- A flight check should be performed by a properly certified pilot.
- Update aircraft records, If required complete Form 337 and obtain FAA field approval for installation if required.

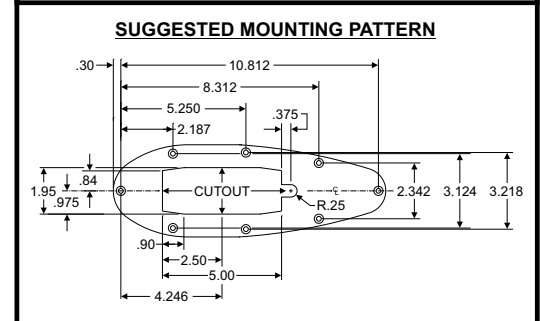
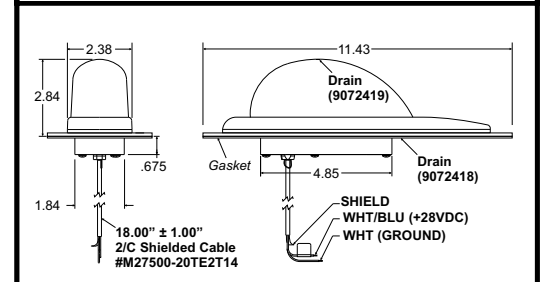
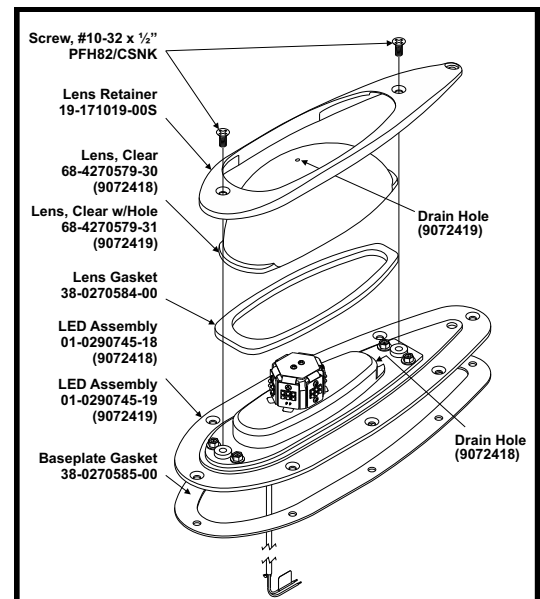

Aviation