

WHELEN[®]

ENGINEERING COMPANY INC.

51 Winthrop Road
Chester, Connecticut 06412-0684
Phone: (860) 526-9504
Internet: www.whelen.com
Sales e-mail: autosale@whelen.com
Customer Service e-mail: custserv@whelen.com

Installation Guide:
R416 ROTA-BEAM™
Super-LED™ Rotating Beacon

Warnings to Installers

Whelen's emergency vehicle warning devices must be properly mounted and wired in order to be effective and safe. Read and follow all of Whelen's written instructions when installing or using this device. Emergency vehicles are often operated under high speed stressful conditions which must be accounted for when installing all emergency warning devices. Controls should be placed within convenient reach of the operator so that they can operate the system without taking their eyes off the roadway. Emergency warning devices can require high electrical voltages and/or currents. Properly protect and use caution around live electrical connections. Grounding or shorting of electrical connections can cause high current arcing, which can cause personal injury and/or vehicle damage, including fire. Many electronic devices used in emergency vehicles can create or be affected by electromagnetic interference. Therefore, after installation of any electronic device it is necessary to test all electronic equipment simultaneously to insure that they operate free of interference from other components within the vehicle. Never power emergency warning equipment from the same circuit or share the same grounding circuit with radio communication equipment. All devices should be mounted in accordance with the manufacturer's instructions and securely fastened to vehicle elements of sufficient strength to withstand the forces applied to the device. Driver and/or passenger air bags (SRS) will affect the way equipment should be mounted. This device should be mounted by permanent installation and within the zones specified by the vehicle manufacturer, if any. Any device mounted in the deployment area of an air bag will damage or reduce the effectiveness of the air bag and may damage or dislodge the device. Installer must be sure that this device, its mounting hardware and electrical supply wiring does not interfere with the air bag or the SRS wiring or sensors. Mounting the unit inside the vehicle by a method other than permanent installation is not recommended as unit may become dislodged during swerving; sudden braking or collision. Failure to follow instructions can result in personal injury. Whelen assumes no liability for any loss resulting from the use of this warning device. **PROPER INSTALLATION COMBINED WITH OPERATOR TRAINING IN THE PROPER USE OF EMERGENCY WARNING DEVICES IS ESSENTIAL TO INSURE THE SAFETY OF EMERGENCY PERSONNEL AND THE PUBLIC.**

Warnings to Users

Whelen's emergency vehicle warning devices are intended to alert other operators and pedestrians to the presence and operation of emergency vehicles and personnel. However, the use of this or any other Whelen emergency warning device does not guarantee that you will have the right-of-way or that other drivers and pedestrians will properly heed an emergency warning signal. Never assume you have the right-of-way. It is your responsibility to proceed safely before entering an intersection, driving against traffic, responding at a high rate of speed, or walking on or around traffic lanes. Emergency vehicle warning devices should be tested on a daily basis to ensure that they operate properly. When in actual use, the operator must ensure that both visual and audible warnings are not blocked by vehicle components (i.e.: open trunks or compartment doors), people, vehicles, or other obstructions. It is the user's responsibility to understand and obey all laws regarding emergency warning devices. The user should be familiar with all applicable laws and regulations prior to the use of any emergency vehicle warning device. Whelen's audible warning devices are designed to project sound in a forward direction away from the vehicle occupants. However, because sustained periodic exposure to loud sounds can cause hearing loss, all audible warning devices should be installed and operated in accordance with the standards established by the National Fire Protection Association.

Safety First

This document provides all the necessary information to allow your Whelen product to be properly and safely installed. Before beginning the installation and/or operation of your new product, the installation technician and operator must read this manual completely. Important information is contained herein that could prevent serious injury or damage.

⚠ WARNING: This product can expose you to chemicals including Methylene Chloride which is known to the State of California to cause cancer, and Bisphenol A, which is known to the State of California to cause birth defects or other reproductive harm. For more information go to www.P65Warnings.ca.gov.

- Proper installation of this product requires the installer to have a good understanding of automotive electronics, systems and procedures.
- Whelen Engineering requires the use of waterproof butt splices and/or connectors if that connector could be exposed to moisture.
- Any holes, either created or utilized by this product, should be made both air- and watertight using a sealant recommended by your vehicle manufacturer.
- Failure to use specified installation parts and/or hardware will void the product warranty.
- If mounting this product requires drilling holes, the installer **MUST** be sure that no vehicle components or other vital parts could be damaged by the drilling process. Check both sides of the mounting surface before drilling begins. Also de-burr the holes and remove any metal shards or remnants. Install grommets into all wire passage holes.
- If this manual states that this product may be mounted with suction cups, magnets, tape or Velcro®, clean the mounting surface with a 50/50 mix of isopropyl alcohol and water and dry thoroughly.
- Do not install this product or route any wires in the deployment area of your air bag. Equipment mounted or located in the air bag deployment area will damage or reduce the effectiveness of the air bag, or become a projectile that could cause serious personal injury or death. Refer to your vehicle owner's manual for the air bag deployment area. The User/Installer assumes full responsibility to determine proper mounting location, based on providing ultimate safety to all passengers inside the vehicle.
- For this product to operate at optimum efficiency, a good electrical connection to chassis ground must be made. The recommended procedure requires the product ground wire to be connected directly to the **NEGATIVE (-)** battery post (this does not include products that use cigar power cords).
- If this product uses a remote device for activation or control, make sure that this device is located in an area that allows both the vehicle and the device to be operated safely in any driving condition.
- Do not attempt to activate or control this device in a hazardous driving situation.
- This product contains either strobe light(s), halogen light(s), high-intensity LEDs or a combination of these lights. Do not stare directly into these lights. Momentary blindness and/or eye damage could result.
- Use only soap and water to clean the outer lens. Use of other chemicals could result in premature lens cracking (crazing) and discoloration. Lenses in this condition have significantly reduced effectiveness and should be replaced immediately. Inspect and operate this product regularly to confirm its proper operation and mounting condition. Do not use a pressure washer to clean this product.
- It is recommended that these instructions be stored in a safe place and referred to when performing maintenance and/or reinstallation of this product.
- **FAILURE TO FOLLOW THESE SAFETY PRECAUTIONS AND INSTRUCTIONS COULD RESULT IN DAMAGE TO THE PRODUCT OR VEHICLE AND/OR SERIOUS INJURY TO YOU AND YOUR PASSENGERS!**

This beacon must be mounted in a normal, 'dome-up' position.

CAUTION: Permanent mounting of this product will require drilling. It is absolutely necessary to make sure that no other vehicle components could be damaged by this process. Check both sides of the mounting surface before starting. If damage is likely, select a different mounting location.

Permanent Surface Mount:

1. Use the base as a template and mark the three mounting holes off onto the mounting surface. Remove the base, and in the center between the three mounting holes, mark the location of the wire passage hole.
2. Drill the mounting holes into the mounting surface with a #16 drill bit. Drill the wire passage hole with a 3/8" drill bit. Remove any burrs from the wire passage hole and install a rubber grommet (user supplied) into the wire hole to protect the wires.
3. The base seal goes between the beacon base and the mounting surface.
4. Feed the wires through the base seal and then through the wire passage hole. Place the base on the mounting surface and align the beacon mounting holes with the mounting holes drilled in step 2. Secure the beacon firmly to the mounting surface using the supplied #10 mounting screws.

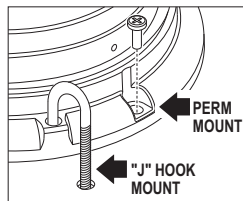
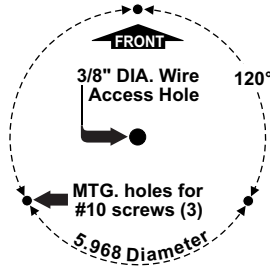

This beacon may be mounted using "J" hooks. Be sure to use the correct "J" hook mounting holes as shown.

Wiring:

WARNING! All customer supplied wires that connect to the positive terminal of the battery must be sized to supply at least 125% of the maximum operating current and FUSED at the battery to carry that load. DO NOT USE CIRCUIT BREAKERS WITH THIS PRODUCT!

Temporary Mount (Optional):

WARNING: The use of any magnetically mounted warning device on the outside of a vehicle in motion is not recommended and is at the

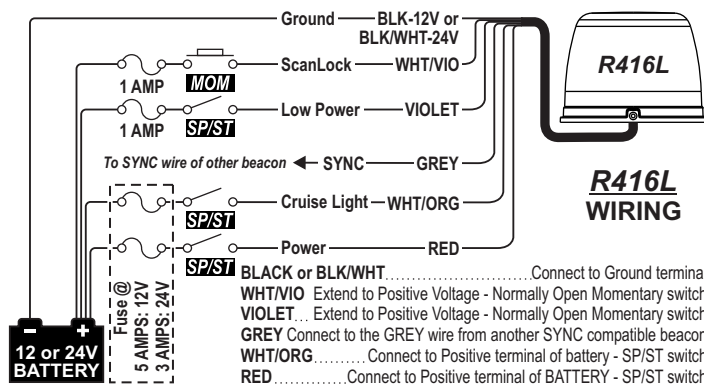

sole risk and responsibility of the user.

Magnetic/suction: Thoroughly clean the proposed mounting surface. For suction cup mounting, wipe the suction cup clean, place the beacon onto its mounting surface and apply gentle pressure

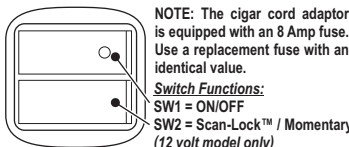

to ensure a good seal has been achieved. The Magnetic/Suction Cups mount the same way but are best suited to a flat, steel surface. **Magnetic:** Place the beacon onto the mounting surface and plug it into the vehicle cigar lighter. Temporary mount models do not offer Low Power or SYNC.

Stud Mount / optional:

1. Remove the base gasket (if present) from the base and discard.
2. Route the wires through the hole in the center of the bracket. If desired, a slot for an alternate wire path is provided in the base.
3. Secure the Stud Bracket onto the base using the hardware provided. Drill wire passage and mounting holes using the information shown. **If alternate wire path is used, drill a .375 DIA wire passage hole. Install a 3/8" grommet (user supplied) into this hole.**

1" N.P.T. Pipe Mount / optional:

1. Remove the base gasket (if present) from the base and discard.

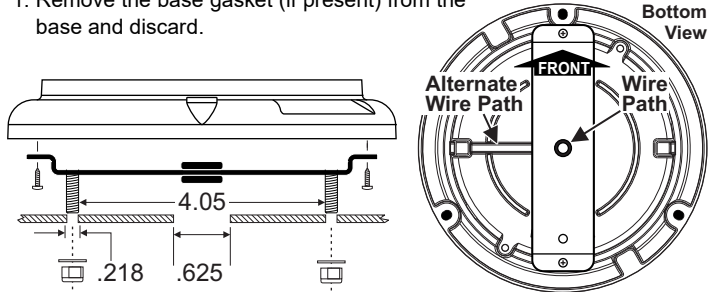

2. Feed beacon wires through pipe. Connect as shown in "Wiring".
3. Screw the beacon onto the pipe, being careful not to pinch or strain the wires. Hand tighten the unit onto the pipe.

Operation:

Low Power:

With the RED (power) wire activated, activate the VIOLET wire to put the beacon into low power operation. Disable this wire to restore normal, high power operation (toggle switch).

Photocell Low Power:

If this beacon is equipped with photocell Hi-Low, the beacon will automatically step down to low power at night. This feature is optional.

Scan-Lock™:

Activate the RED wire (or WHT/ORG for cruise mode) to turn on the beacon.

To cycle forward through patterns, activate the WHT/VIO wire for less than 1 second and release.

To cycle backward through patterns, activate the WHT/VIO wire for more than 1 second and release.

To choose a pattern, allow it to run for more than 5 seconds. The beacon will now display this pattern when active.

To reset to the factory default pattern, turn off power, activate the WHT/VIO wire, then turn power back on.

Use a normally open momentary switch to control Scan-lock™. Cigar cord models have a momentary switch on the plug to control Scan-Lock™ as well as an On/Off switch.

Cruise Light:

NOTE: For the cruise option to function, the RED power wire must not be activated.

Activate the WHT/ORG wire to turn on the cruise light. There are 4 intensity levels. Cycle through the 4 intensity levels using Scanlock™ as you would when choosing a flash pattern (See ScanLock™).

SYNC:

All beacons configured to display the Phase 1 mode of a pattern will flash simultaneously. Any beacons configured to display the Phase 2 mode of a pattern, will alternate with any Phase 1 beacons of the same pattern.

To sync two beacons, configure both beacons to display the same Phase 1 pattern. With the power off, connect the GREY wires from each beacon together. When the beacons are activated, their patterns will be synchronized. To configure the two beacons to alternate their patterns, advance the pattern of either beacon to the Phase 2 mode of the current pattern.

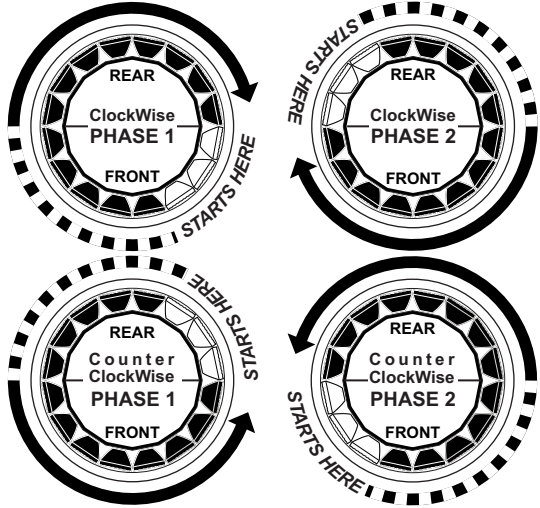

NOTE: A 12 volt model is shown here. In 24 volt models sequences will start with 4 LEDs lit instead of 3 as shown making the patterns appear to flow less smoothly.

Flash Patterns:

- | | |
|---------------|---|
| SYNC PATTERNS | 1. Rotator 75 clockwise Phase 1 (Default Pattern) |
| | 2. Rotator 75 clockwise Phase 2 |
| | 3. Rotator 75 counter-clockwise Phase 1 |
| | 4. Rotator 75 counter-clockwise Phase 2 |
| | 5. Rotator 150 clockwise Phase 1 |
| | 6. Rotator 150 clockwise Phase 2 |
| | 7. Rotator 150 counter-clockwise Phase 1 |
| | 8. Rotator 150 counter-clockwise Phase 2 |

The following example will demonstrate how to use SYNC with more than 2 beacons. You have 4 beacons; 2 on the rear (driver), 2 on the rear (passenger). With all wiring complete, turn on the 4 beacons. As shipped from the factory, all the beacons will simultaneously display the same pattern (Rotator 75 CW Phase 1).

For the passenger side to alternate with the driver side, change the patterns for either side to Phase 2 of the same pattern. **Do not SYNC more than 8 beacons.**

- | | |
|------------------|--|
| REGULAR PATTERNS | 9. Rotator 60 clockwise |
| | 10. Rotator 60 counter-clockwise |
| | 11. Rotator 90 clockwise |
| | 12. Rotator 90 counter-clockwise |
| | 13. Rotator 120 clockwise |
| | 14. Rotator 120 counter-clockwise |
| | 15. Rotator 300 clockwise |
| | 16. Rotator 300 counter-clockwise |
| | 17. Rotator Double 150 Seq. / clockwise |
| | 18. Rotator Double 150 Seq. / counter-clockwise |
| | 19. Rotator Triple 300/75 Seq. / clockwise |
| | 20. Rotator Triple 300/75 Seq. / counter-clockwise |
| | 21. Rotator Quad 300 Seq. / clockwise |
| | 22. Rotator Quad 300 Seq. / counter-clockwise |
| | 23. Rotator ModuFlash clockwise |
| | 24. Rotator ModuFlash counter-clockwise |
| | 25. Oscillator 75 Right |
| | 26. Oscillator 75 Left |
| | 27. Sweep 40 Right |
| | 28. Sweep 40 Left |
| | 29. Sweep 75 Right |
| | 30. Sweep 75 Left |
| | 31. Sweep 150 Right |
| | 32. Sweep 150 Left |

Oscillator

Starts on one side, circles completely around the beacon, then circles back.

Sweep

First half of beacon lights up on one side sweeping to opposite side. Action repeats for other half of beacon.

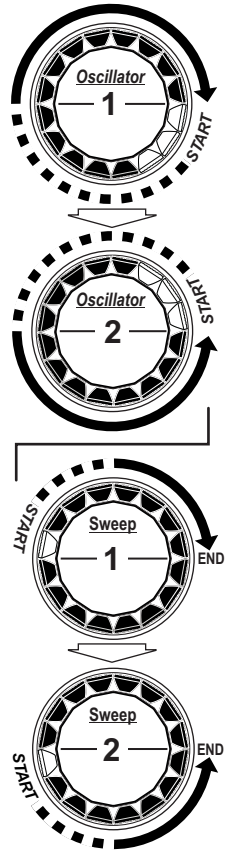

IMPORTANT WARNING!

CAUTION! DO NOT LOOK DIRECTLY AT THESE LED'S WHILE THEY ARE ON. MOMENTARY BLINDNESS AND/OR EYE DAMAGE COULD RESULT!

IMPORTANT: It is the responsibility of the installation technician to make sure that the installation and operation of this product will not interfere with or compromise the operation or efficiency of any vehicle equipment! Before returning the vehicle to active service, visually confirm the proper operation of this product, as well as all vehicle components/equipment.