

# WHELEN<sup>®</sup>

## ENGINEERING COMPANY INC.

51 Winthrop Road  
Chester, Connecticut 06412-0684  
Phone: (860) 526-9504  
Internet: [www.whelen.com](http://www.whelen.com)  
Sales e-mail: [autosale@whelen.com](mailto:autosale@whelen.com)  
Customer Service e-mail: [custserv@whelen.com](mailto:custserv@whelen.com)

Installation Guide:  
Inner Edge<sup>®</sup> XLP Low Current DUO+<sup>™</sup> Lightbar  
(6- & 12-Light)

### Warnings to Installers

Whelen's emergency vehicle warning devices must be properly mounted and wired in order to be effective and safe. Read and follow all of Whelen's written instructions when installing or using this device. Emergency vehicles are often operated under high speed stressful conditions which must be accounted for when installing all emergency warning devices. Controls should be placed within convenient reach of the operator so that they can operate the system without taking their eyes off the roadway. Emergency warning devices can require high electrical voltages and/or currents. Properly protect and use caution around live electrical connections. Grounding or shorting of electrical connections can cause high current arcing, which can cause personal injury and/or vehicle damage, including fire. Many electronic devices used in emergency vehicles can create or be affected by electromagnetic interference. Therefore, after installation of any electronic device it is necessary to test all electronic equipment simultaneously to insure that they operate free of interference from other components within the vehicle. Never power emergency warning equipment from the same circuit or share the same grounding circuit with radio communication equipment. All devices should be mounted in accordance with the manufacturer's instructions and securely fastened to vehicle elements of sufficient strength to withstand the forces applied to the device. Driver and/or passenger air bags (SRS) will affect the way equipment should be mounted. This device should be mounted by permanent installation and within the zones specified by the vehicle manufacturer, if any. Any device mounted in the deployment area of an air bag will damage or reduce the effectiveness of the air bag and may damage or dislodge the device. Installer must be sure that this device, its mounting hardware and electrical supply wiring does not interfere with the air bag or the SRS wiring or sensors. Mounting the unit inside the vehicle by a method other than permanent installation is not recommended as unit may become dislodged during swerving; sudden braking or collision. Failure to follow instructions can result in personal injury. Whelen assumes no liability for any loss resulting from the use of this warning device. **PROPER INSTALLATION COMBINED WITH OPERATOR TRAINING IN THE PROPER USE OF EMERGENCY WARNING DEVICES IS ESSENTIAL TO INSURE THE SAFETY OF EMERGENCY PERSONNEL AND THE PUBLIC.**

### Warnings to Users

Whelen's emergency vehicle warning devices are intended to alert other operators and pedestrians to the presence and operation of emergency vehicles and personnel. However, the use of this or any other Whelen emergency warning device does not guarantee that you will have the right-of-way or that other drivers and pedestrians will properly heed an emergency warning signal. Never assume you have the right-of-way. It is your responsibility to proceed safely before entering an intersection, driving against traffic, responding at a high rate of speed, or walking on or around traffic lanes. Emergency vehicle warning devices should be tested on a daily basis to ensure that they operate properly. When in actual use, the operator must ensure that both visual and audible warnings are not blocked by vehicle components (i.e.: open trunks or compartment doors), people, vehicles, or other obstructions. It is the user's responsibility to understand and obey all laws regarding emergency warning devices. The user should be familiar with all applicable laws and regulations prior to the use of any emergency vehicle warning device. Whelen's audible warning devices are designed to project sound in a forward direction away from the vehicle occupants. However, because sustained periodic exposure to loud sounds can cause hearing loss, all audible warning devices should be installed and operated in accordance with the standards established by the National Fire Protection Association.

### Safety First

This document provides all the necessary information to allow your Whelen product to be properly and safely installed. Before beginning the installation and/or operation of your new product, the installation technician and operator must read this manual completely. Important information is contained herein that could prevent serious injury or damage.

**⚠ WARNING:** This product can expose you to chemicals including Lead which is known to the State of California to cause cancer and birth defects or other reproductive harm. For more information go to [www.P65Warnings.ca.gov](http://www.P65Warnings.ca.gov).

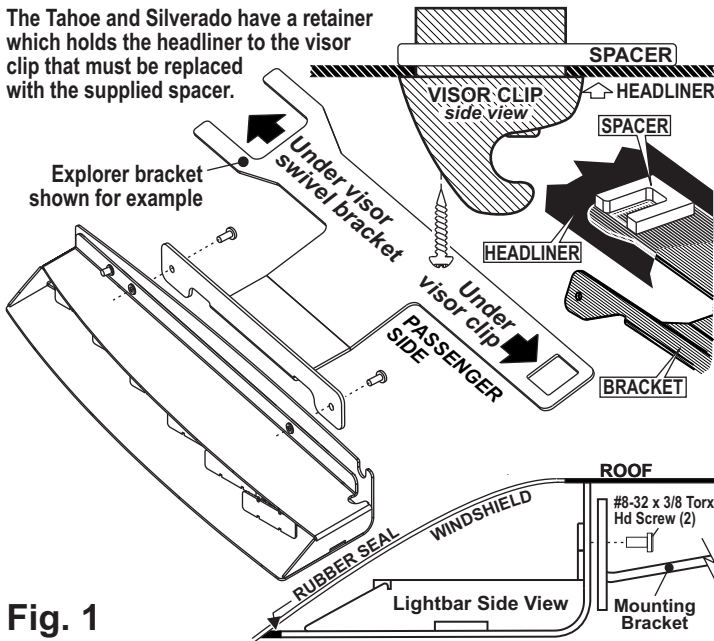
- **Proper installation of this product requires the installer to have a good understanding of automotive electronics, systems and procedures.**
- **Whelen Engineering requires the use of waterproof butt splices and/or connectors if that connector could be exposed to moisture.**
- **Any holes, either created or utilized by this product, should be made both air- and watertight using a sealant recommended by your vehicle manufacturer.**
- **Failure to use specified installation parts and/or hardware will void the product warranty.**
- **If mounting this product requires drilling holes, the installer MUST be sure that no vehicle components or other vital parts could be damaged by the drilling process. Check both sides of the mounting surface before drilling begins. Also de-burr the holes and remove any metal shards or remnants. Install grommets into all wire passage holes.**
- **If this manual states that this product may be mounted with suction cups, magnets, tape or Velcro<sup>®</sup>, clean the mounting surface with a 50/50 mix of isopropyl alcohol and water and dry thoroughly.**
- **Do not install this product or route any wires in the deployment area of your air bag. Equipment mounted or located in the air bag deployment area will damage or reduce the effectiveness of the air bag, or become a projectile that could cause serious personal injury or death. Refer to your vehicle owner's manual for the air bag deployment area. The User/Installer assumes full responsibility to determine proper mounting location, based on providing ultimate safety to all passengers inside the vehicle.**
- **For this product to operate at optimum efficiency, a good electrical connection to chassis ground must be made. The recommended procedure requires the product ground wire to be connected directly to the NEGATIVE (-) battery post (this does not include products that use cigar power cords).**
- **If this product uses a remote device for activation or control, make sure that this device is located in an area that allows both the vehicle and the device to be operated safely in any driving condition.**
- **Do not attempt to activate or control this device in a hazardous driving situation.**
- **This product contains either strobe light(s), halogen light(s), high-intensity LEDs or a combination of these lights. Do not stare directly into these lights. Momentary blindness and/or eye damage could result.**
- **Use only soap and water to clean the outer lens. Use of other chemicals could result in premature lens cracking (crazing) and discoloration. Lenses in this condition have significantly reduced effectiveness and should be replaced immediately. Inspect and operate this product regularly to confirm its proper operation and mounting condition. Do not use a pressure washer to clean this product.**
- **It is recommended that these instructions be stored in a safe place and referred to when performing maintenance and/or reinstallation of this product.**
- **FAILURE TO FOLLOW THESE SAFETY PRECAUTIONS AND INSTRUCTIONS COULD RESULT IN DAMAGE TO THE PRODUCT OR VEHICLE AND/OR SERIOUS INJURY TO YOU AND YOUR PASSENGERS!**

**IMPORTANT! The lightbar should be a minimum of 16" from radio antennas!**

**Installation / Standard:**

1. Loosen (do not remove) the three screws securing the passenger-side visor swivel bracket to the vehicle.

The Tahoe and Silverado have a retainer which holds the headliner to the visor clip that must be replaced with the supplied spacer.

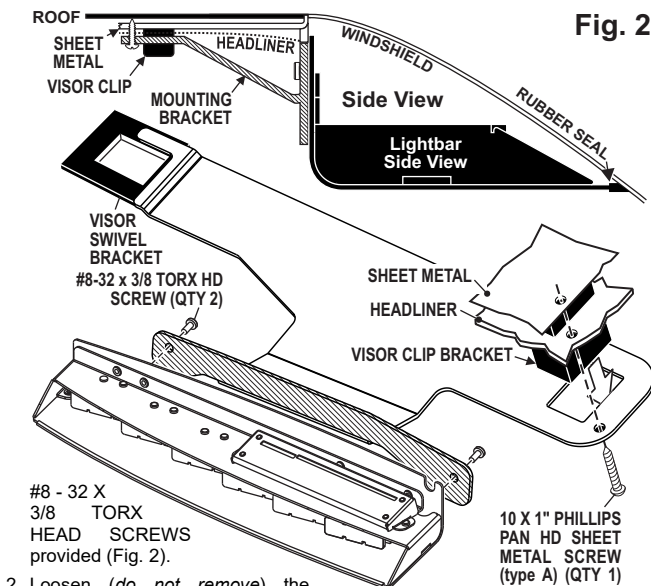


**Fig. 1**

2. Remove screws securing vehicles visor clip and remove clip and hardware.
3. Secure mounting bracket to Inner Edge housing using hardware provided (Fig. 1).
4. Position the keyed opening of the mounting bracket directly under the location of the visor clip removed in step 2 and remount the visor clip in its original location using the original hardware (See Spacer installation in Fig. 1).
5. Firmly tighten any hardware loosened in this procedure.
6. Repeat this procedure for the driver-side assembly.
7. When rubber seal is in full contact with vehicle windshield and roof preventing light output from entering passenger compartment tighten mounting hardware.
8. Route the lightbar cable down the vehicle A-pillar to your control head. Make all wiring connections using the information in the wiring diagram.

**Installation / Caprice:**

1. Secure the mounting bracket to the Inner Edge housing using the two



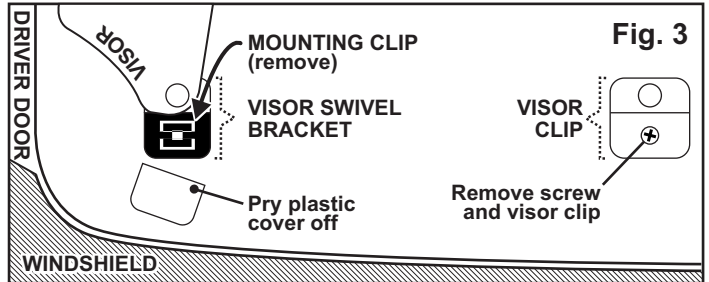
**Fig. 2**

2. Loosen (do not remove) the screws securing the passenger-side visor swivel bracket to the vehicle.
3. Slide the outside end of the mounting bracket under the visor swivel bracket (Fig. 2). At the same time slip the rectangular hole in the other end of the mounting bracket over the visor clip bracket. With the mounting bracket in position retighten the visor swivel bracket hardware.

4. Using the screw hole in the mounting bracket as a guide, drill a pilot hole into the sheet metal behind the headliner and secure other side of mounting bracket using the supplied #10 X 1" PHILLIPS PAN HEAD SHEET METAL SCREW.
5. Repeat this procedure for the driver-side assembly.
6. The rubber seal should be in full contact with the windshield and the rear of the lightbar should be in contact with the roof to prevent light from entering the passenger compartment. When this has been achieved, tighten all mounting hardware firmly to maintain contact (Fig. 2).
7. Route the lightbar cable down the vehicle A-pillar to your control head and make all wiring connections using the information in the wiring diagram.

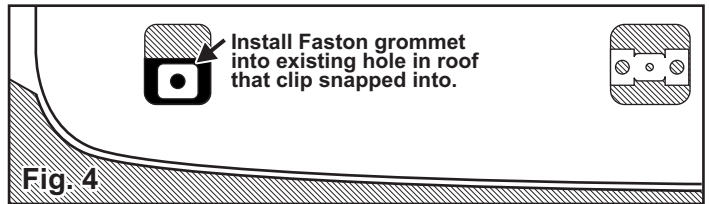
**Installation 2013 Ford Fusion:**

Figures 1 thru 3 show the driver side of the interior, looking up at the roof.

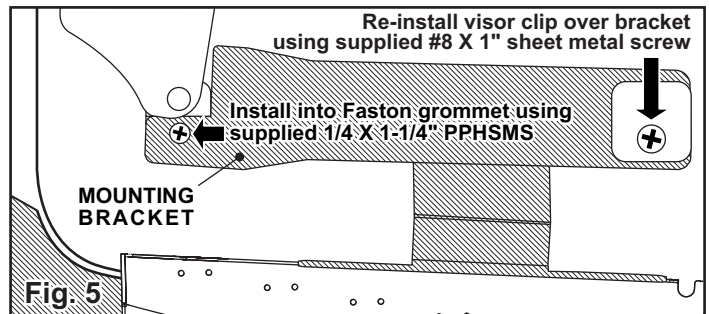


**Fig. 3**

1. On the driver side visor swivel bracket, carefully pry the plastic cover off of the front of the bracket (Fig. 3). The lightbar mounting bracket will sit in the space that the cover occupied. **NOTE: Pry the cover off using two flat blade screwdrivers on each side to avoid braking the cover. The cover will not be used here but should be saved in case you wish to remove the lightbar in the future.**
2. Remove the swivel bracket mounting clip (located under the cover you removed in step 1) and lift the swivel bracket assembly out. Install the supplied fastex grommet into the hole in the roof sheet metal which the clip snapped into. Reinsert the swivel bracket assembly (Figs. 3 & 4).

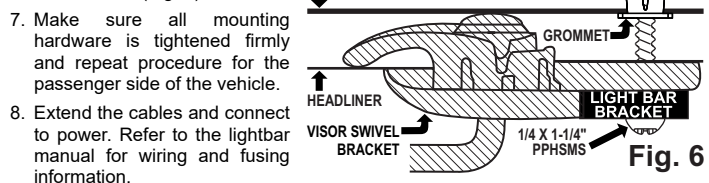


**Fig. 4**



**Fig. 5**

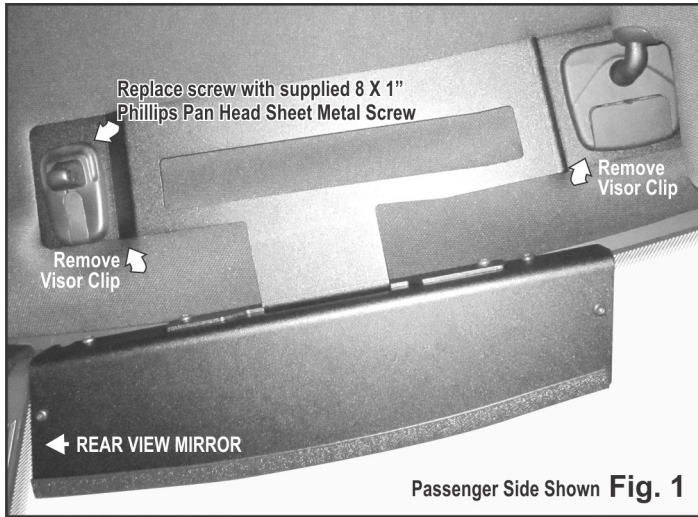
3. On the vehicle visor clip, remove the screw holding on the clip (The supplied #8 X 1" sheet metal screw will replace this screw) and remove the clip. (Figs. 3 & 4).
4. Secure the mounting bracket to the lightbar and position the bracket where it will mount on the vehicle (Fig. 1 side view). **NOTE: The rubber seal should be in full contact with the windshield and the rear of the lightbar should be in contact with the roof to prevent light from entering the passenger compartment**
5. Secure the lightbar bracket to the swivel mount using the supplied 1/4 X 1-1/4" Phillips Pan Head Sheet Metal Screw. This screw will thread into the fastex grommet you installed in step 2 and the bracket sits where the cover was (Fig. 6).
6. Line the rectangular hole in the other end of the lightbar bracket, up with the visor clip and install the visor clip over the lightbar bracket using the supplied #8 X 1" Sheet Metal Screw (Fig. 5).



**Fig. 6**

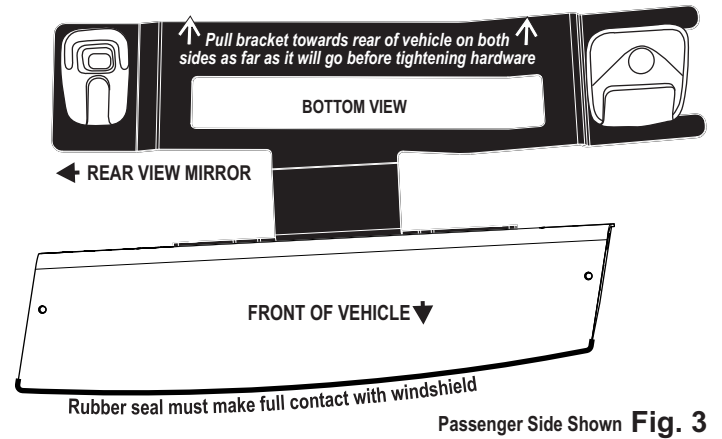
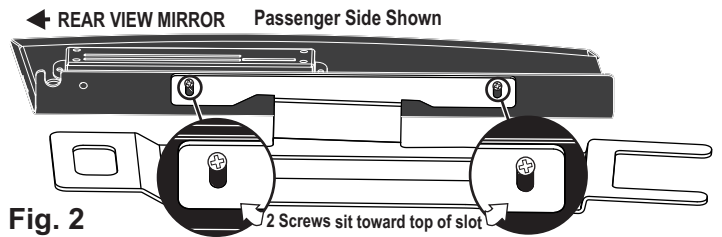
7. Make sure all mounting hardware is tightened firmly and repeat procedure for the passenger side of the vehicle.
8. Extend the cables and connect to power. Refer to the lightbar manual for wiring and fusing information.

**Installation 2019 - 2020 Dodge Ram 1500:  
Inner Edge XLP**



1. Remove the vehicle Visor Clips. The bracket will sit under these clips after mounting (Fig. 1).
2. Mount the bracket to the light array as shown so the mounting hardware sits at the top of the mounting slot on the bracket (Fig. 2). Tighten hardware firmly.
3. Replace the vehicle clip mounting screw near the rear view mirror with the supplied 8 X 1" Phillips Pan Head Sheet Metal

Screw (Fig. 1). Loosely mount the bracket to the vehicle then pull the bracket as far back from the windshield as it goes (Fig. 3). With the bracket in place tighten the mounting hardware.



## Wiring and Operation:

**WARNING!** All customer supplied wires that connect to the positive terminal of the battery must be sized to supply at least 125% of the maximum operating current and **FUSED** at the battery to carry that load. **DO NOT USE CIRCUIT BREAKERS WITH THIS PRODUCT!**

This lightbar is powered and controlled by an 8-conductor cable. The lightbar operates in 4 basic modes. Take-down, Flashing Take-down, Warning Override and Warning. You can operate in any one of these modes or combine them. When you switch on more than one mode they will operate as follows:

- Take-down will override any other mode.
- Flashing Take-down will flash alternately with either Warning Override or Warning if either is activated when Flashing Take-Down is activated.
- Warning Override will override Warning.

**Example:** If you switched on all four modes at once, *Take-down* would run. If you turn Take-down off, (Leaving Flashing Take-down, Warning Override and Warning) Flashing Take-down would alternate with Warning Override.

This allows you to run in one mode and then switch to another by only turning off one switch instead of turning one off and another on. **Example:** If you activate Take-down and Warning, you will run in Take-down mode. By switching off Take-down you will immediately go to Warning (see chart below for other options).

### White/Green - Scan-Lock™

The WHITE/GREEN wire allows you to choose from available flash patterns. You must activate the lighthouse to select a pattern:

**TO CYCLE THROUGH ALL PATTERNS:** To cycle forward, apply +12 VDC to the WHITE/GREEN wire for less than 1 second and release. To cycle backward, apply +12 VDC to the WHITE/GREEN wire for more than 1 second and release.

**TO SET A PATTERN AS DEFAULT:** When the pattern is displayed, allow it to run for more than 5 seconds. The lighthouse will now display this pattern when activated.

SWITCH POSITIONS				FUNCTION	AVAILABLE PATTERNS				
Warning	Flashing TakeDown	Takedown	Warning Override		Warning	Flashing Takedown	Warning & Flashing TD	Takedown	Warning Override
off	off	off	off	OFF					
ON				WARNING	1 - 42				
	ON			FLASHING TAKEDOWN		43-58			
ON	ON			FLASHING TAKEDOWN & WARNING alternate		1 - 33			
		ON		TAKEDOWN				59-61	
ON		ON		TAKEDOWN	1 - 42			59-61	
	ON	ON		TAKEDOWN		43-58		59-61	
ON	ON	ON		TAKEDOWN		1-33		59-61	
			ON	WARNING OVERRIDE (#12 is the Default Pattern)					1 - 40
ON			ON	WARNING OVERRIDE (#12 is the Default Pattern)					1 - 40
	ON		ON	FLASHING TD & WARNING OVERRIDE alternate		1 - 33			
ON	ON		ON	FLASHING TD & WARNING OVERRIDE alternate		1 - 33			
		ON	ON	TAKEDOWN & WARNING OVERRIDE alternate				59-61	1 - 40
ON		ON	ON	TAKEDOWN				59-61	1 - 40
	ON	ON	ON	TAKEDOWN		1 - 33		59-61	
ON	ON	ON	ON	TAKEDOWN		1 - 33		59-61	

**TO RESET TO THE FACTORY DEFAULT PATTERN:** Turn off power and apply +12 VDC to the WHITE/GREEN wire while turning power on.

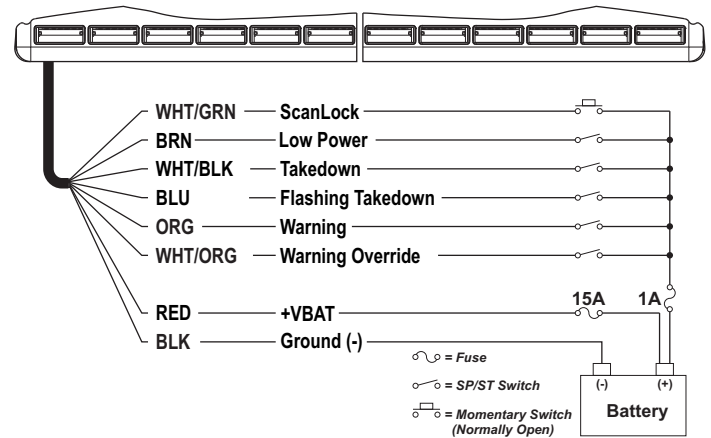
**A normally open momentary switch is best suited for Scan-Lock operation.**

### Brown: Hi/Low Power

This feature works for Warning or Warning Override. With low power activated, you may choose from four light intensities using Scanlock. The type of switch depends on how you wish Hi/Low to function:

**Latching Mode:** (momentary switch) Apply positive voltage to the BROWN wire for less than 1 second and the lightbar is "latched" into low power. Apply positive voltage for several seconds and release to restore normal operation.

**Level Mode:** (toggle switch) Applying positive voltage to the wire for more than 1 second holds the lightbar in low power mode until voltage is removed.



### Warning Patterns:

- ActionScan™
- SignalAlert™ 75 ALT
- SignalAlert™ 75 ALT/IO/CH
- CometFlash® 75 ALT
- CometFlash® 75 ALT/IO/CH
- DoubleFlash 75 ALT
- DoubleFlash 75 ALT/IO/CH
- SingleFlash 75 ALT
- SingleFlash 75 ALT/IO/CH
- LongBurst™ 75 ALT
- LongBurst™ 75 ALT/IO/CH
- SingleFlash 60 ALT
- SingleFlash 60 ALT/IO/CH
- SingleFlash 90 ALT
- SingleFlash 90 ALT/IO/CH
- SingleFlash 120 ALT
- SingleFlash 120 ALT/IO/CH
- SingleFlash 240 ALT
- SingleFlash 240 ALT/IO/CH
- DoubleFlash 120 ALT
- DoubleFlash 120 ALT/IO/CH
- ActionFlash™ 75 ALT
- ActionFlash™ 75 ALT/IO/CH

- ActionFlash™ 150 ALT
- ActionFlash™ 150 ALT/IO/CH
- MicroBurst™ ALT
- MicroBurst™ ALT/IO/CH
- PingPong™ 75 ALT
- PingPong™ 75 ALT/IO/CH
- FilmFlam ALT
- FilmFlam ALT/IO/CH
- Moduflash™ ALT
- Moduflash™ ALT/IO/CH
- Cylon 1 Lamp
- Cylon 2 Lamp
- Cylon Chaser
- Eyeballs SYNC
- Eyeballs IN/OUT
- Eyeballs IN/OUT
- Eyeballs CRAZY
- CRUISE - LOW
- CRUISE - HIGH

ALT = Alternating  
 ALT/IO/CH = Pattern cycles from Alternating to IN/OUT to Checkerboard

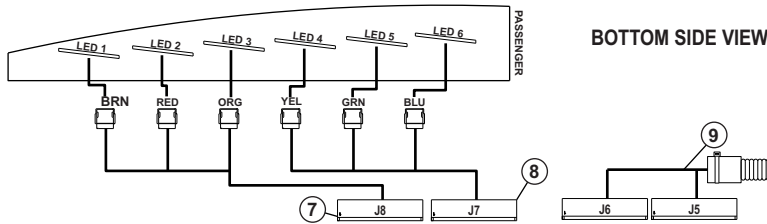
### Flashing Take-Down Patterns:

- SingleFlash 240
- DoubleFlash 120
- ActionFlash™ 75
- ActionFlash™ 150
- MicroBurst™
- PingPong™ 75
- FilmFlam
- Moduflash™
- SignalAlert™ 75
- CometFlash® 75
- DoubleFlash 75
- SingleFlash 75
- LongBurst™ 75
- SingleFlash 90
- SingleFlash 120

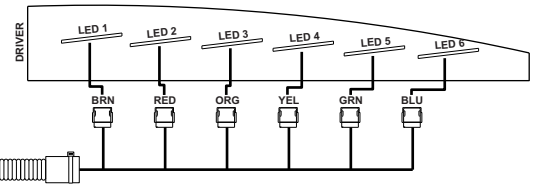
### Take-Down Configurations:

- ALL
- INNER
- OUTER





**BOTTOM SIDE VIEW**

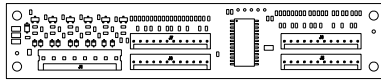


**LABEL DETAIL, PASSENGER SIDE BRACKET ONLY**

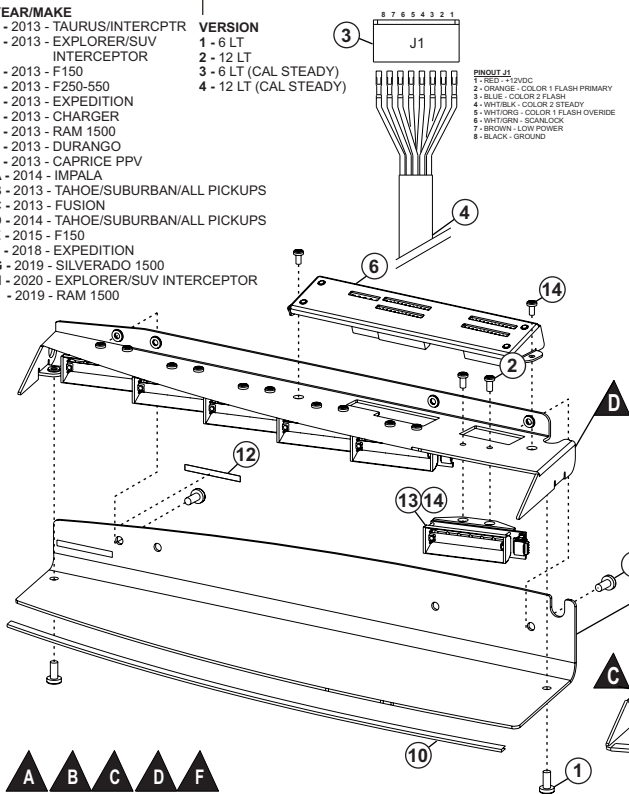
**PART NUMBER KEY**  
01-0687688-

- YEAR/MAKE**
- 1 - 2013 - TAURUS/INTERCEPTOR
  - 2 - 2013 - EXPLORER/SUV INTERCEPTOR
  - 3 - 2013 - F150
  - 4 - 2013 - F250-550
  - 5 - 2013 - EXPEDITION
  - 6 - 2013 - CHARGER
  - 7 - 2013 - RAM 1500
  - 8 - 2013 - DURANGO
  - 9 - 2013 - CAPRICE PPV
  - A - 2014 - IMPALA
  - B - 2013 - TAHOE/SUBURBAN/ALL PICKUPS
  - C - 2013 - FUSION
  - D - 2014 - TAHOE/SUBURBAN/ALL PICKUPS
  - E - 2015 - F150
  - F - 2018 - EXPEDITION
  - G - 2019 - SILVERADO 1500
  - H - 2020 - EXPLORER/SUV INTERCEPTOR
  - I - 2019 - RAM 1500

- VERSION**
- 1 - 6 LT
  - 2 - 12 LT
  - 3 - 6 LT (CAL STEADY)
  - 4 - 12 LT (CAL STEADY)

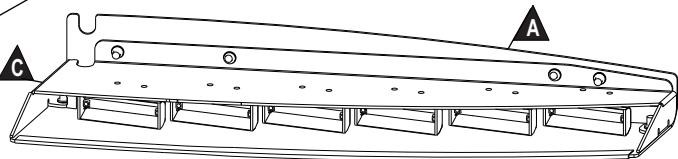


- PINOUT J1**
- 1- RED - 12VDC
  - 2- ORANGE - COLOR 1 FLASH PRIMARY
  - 3- BLUE - COLOR 2 FLASH
  - 4- WHITE/K - COLOR 3 STEADY
  - 5- WHITE/G - COLOR 1 FLASH OVERRIDE
  - 6- WHITE/GN - SIGNAL GND
  - 7- BROWN - LOW POWER
  - 8- BLACK - GROUND



**A B C D E F**  
SEE BELOW AND NEXT PAGE FOR VEHICLE SPECIFIC COMPONENT REQUIREMENTS

QTY	QTY	QTY	QTY	ITEM	PART NUMBER	DESCRIPTION
		*			01-0687688-__1	DUO INNER EDGE XLP, LC 6 LT
		*			01-0687688-__2	DUO INNER EDGE XLP, LC 12 LT
	*				01-0687688-__3	DUO INNER EDGE XLP, LC 6 LT (CAL STEADY)
	*				01-0687688-__4	DUO INNER EDGE XLP, LC 12 LT (CAL STEADY)
8	4	8	4	1	14-08228C-06D	SCREW, 8-32 X 3/8" PAN TORX HD ROLOK SS BLACK OXIDE
26	14	26	14	2	14-040216-04H	SCREW, 4-40 X 1/4 PPHMS 410SS BLACK PASSIVATE
1	1	1	1	3	39-1M17672-08	HOUSING, PLUG 8 POS 18 AWG SL-156 W/ LOCKING RAMP
1	1	1	1	4	46-0743403-00	CABLE 9C 18 GA TPR 20' SL-156 SCKTS ONE END
1	1	1	1	5	26-0215001-06	TY WRAP, 6" BLACK
1	1	1	1	6	01-026E763-01	SUB ASSY, LC I/O INNER-EDGE DUO XLP
1	1	1	1	7	46-076E764-00	HARNESS PASSENGER J8 INNER EDGE XLP
1	1	1	1	8	46-076E764-01	HARNESS PASSENGER J7 INNER EDGE XLP
1	-	1	-	9	46-076E764-02	HARNESS DRIVER J5&J6 INNER EDGE XLP
2	1	2	1	10	38-0546827-14	TRIM, SEAL HOUSING/WINDSHIELD 13.600" LENGTH INNER EDGE XLP
1	1	1	1	11	10-056E563-30	LABEL, WHELEN LOGO, 2.75" GREY
1	1	1	1	12	10-056F516-__	LABEL, INNER EDGE XLP, M/N P/N DUO
6	-	6	-	13	01-026E756D_3	SUB ASSY, WARNING *WHT DUO INNER-EDGE XLP, DRVR
6	6	6	6	14	01-026E756P_3	SUB ASSY, WARNING *WHT DUO INNER-EDGE XLP, PASS



**2013 - TAHOE/SUBURBAN/ALL PICKUPS**

QTY	QTY	ITEM	PART NUMBER	DESCRIPTION
	*		01-0687688-B1	FINAL, DUO INNER EDGE XLP, 6 LIGHT
*			01-0687688-B2	FINAL, DUO INNER EDGE XLP, 12 LIGHT
1	-	A	11-36E644-107	BASE, HOUSING DRVR 12 TAHOE INNER EDGE XLP BLACK
1	1	B	11-36E644-007	BASE, HOUSING PASS 12 TAHOE INNER EDGE XLP BLACK
1	-	C	11-26E761-107	COVER, TOP DRVR 2012 TAHOE DUO INNER EDGE XLP BLACK
1	1	D	11-26E761-007	COVER, TOP PASS 2012 TAHOE DUO INNER EDGE XLP BLACK
1	-	E	07-287449-123	BRACKET, VISOR MT DRVR TAHOE INNER EDGE XLP BLACK
1	1	F	07-287449-023	BRACKET, VISOR MT PASS TAHOE INNER EDGE XLP BLACK
4	2	G	14-08228C-06D	SCREW, 8-32 X 3/8" PAN TORX HD ROLOK SS BLACK OXIDE

**2014 - TAHOE/SUBURBAN/ALL PICKUPS**

QTY	QTY	ITEM	PART NUMBER	DESCRIPTION
	*		01-0687688-D1	FINAL, DUO INNER EDGE XLP, 6 LIGHT
*			01-0687688-D2	FINAL, DUO INNER EDGE XLP, 12 LIGHT
1	-	A	11-36F641-107	BASE, HOUSING DRVR 14 TAHOE INNER EDGE XLP BLACK
1	1	B	11-36F641-007	BASE, HOUSING PASS 14 TAHOE INNER EDGE XLP BLACK
1	-	C	11-26F653-107	COVER, TOP DRVR 2014 TAHOE DUO INNER EDGE XLP BLACK
1	1	D	11-26F653-007	COVER, TOP PASS 2014 TAHOE DUO INNER EDGE XLP BLACK
1	-	E	07-287726-123	BRACKET, VISOR MT DRVR TAHOE INNER EDGE XLP BLACK
1	1	F	07-287726-023	BRACKET, VISOR MT PASS TAHOE INNER EDGE XLP BLACK
4	2	G	14-08228C-06D	SCREW, 8-32 X 3/8" PAN TORX HD ROLOK SS BLACK OXIDE

**CHEVROLET**

**2013 - CAPRICE PPV**

QTY	QTY	ITEM	PART NUMBER	DESCRIPTION
	*		01-0687688-91	FINAL, DUO INNER EDGE XLP, 6 LIGHT
*			01-0687688-92	FINAL, DUO INNER EDGE XLP, 12 LIGHT
1	-	A	11-36E494-107	BASE, HOUSING DRVR 12 CAPRICE INNER EDGE XLP BLACK
1	1	B	11-36E494-007	BASE, HOUSING PASS 12 CAPRICE INNER EDGE XLP BLACK
1	-	C	11-26E740-107	COVER, TOP DRVR 12 CAPRICE DUO INNER EDGE XLP BLACK
1	1	D	11-26E740-007	COVER, TOP PASS 12 CAPRICE DUO INNER EDGE XLP BLACK
1	-	E	07-287419-123	BRACKET, VISOR MT DRVR CAPRICE INNER EDGE XLP BLACK
1	1	F	07-287419-023	BRACKET, VISOR MT PASS CAPRICE INNER EDGE XLP BLACK
4	2	G	14-08228C-06D	SCREW, 8-32 X 3/8" PAN TORX HD ROLOK SS BLACK OXIDE
2	1	H	15-10141B-162	SCREW, 10 X 1" PPH SMS TYPE A SS BLACK OXIDE

**2014 - IMPALA**

QTY	QTY	ITEM	PART NUMBER	DESCRIPTION
	*		01-0687688-A1	FINAL, DUO INNER EDGE XLP, 6 LIGHT
*			01-0687688-A2	FINAL, DUO INNER EDGE XLP, 12 LIGHT
1	-	A	11-36G260-107	BASE, HOUSING DRVR 2014 IMPALA INNER EDGE XLP BLACK
1	1	B	11-36G260-007	BASE, HOUSING PASS 2014 IMPALA INNER EDGE XLP BLACK
1	-	C	11-26G262-107	COVER, TOP DRVR 2014 IMPALA DUO INNER EDGE XLP BLACK
1	1	D	11-26G262-007	COVER, TOP PASS 2014 IMPALA DUO INNER EDGE XLP BLACK
1	-	E	07-287946-123	BRACKET, VISOR MT DRVR IMPALA INNER EDGE XLP BLACK
1	1	F	07-287946-023	BRACKET, VISOR MT PASS IMPALA INNER EDGE XLP BLACK
4	2	G	14-08228C-06D	SCREW, 8-32 X 3/8" PAN TORX HD ROLOK SS BLACK OXIDE

**2019 - SILVERADO 1500**

QTY	QTY	ITEM	PART NUMBER	DESCRIPTION
	*		01-0687688-G1	FINAL, DUO INNER EDGE XLP, 6 LIGHT
*			01-0687688-G2	FINAL, DUO INNER EDGE XLP, 12 LIGHT
1	-	A	11-36J270-107	BASE, HOUSING DRVR SILVERADO 2019 INNER EDGE XLP BLK
1	1	B	11-36J270-007	BASE, HOUSING PASS SILVERADO 2019 INNER EDGE XLP BLK
1	-	C	11-26J272-107	COVER, TOP DRVR 19 SILVERADO WC INNER EDGE XLP BLK
1	1	D	11-26J272-007	COVER, TOP PASS 19 SILVERADO WC INNER EDGE XLP BLK
1	-	E	07-288558-123	BRCKT, VISOR MT DRV SILVERADO 2019 INNER EDGE XLP BLK
1	1	F	07-288558-023	BRCKT, VISOR MT PAS SILVERADO 2019 INNER EDGE XLP BLK
4	2	G	14-08228C-06D	SCREW, 8-32 X 3/8" PAN TORX HD ROLOK SS BLACK OXIDE

# FORD

## 2013 - TAURUS/INTERCEPTOR

QTY	QTY	ITEM	PART NUMBER	DESCRIPTION
	*		01-0687688-11	FINAL, DUO INNER EDGE XLP, 6 LIGHT
*			01-0687688-12	FINAL, DUO INNER EDGE XLP, 12 LIGHT
1	-	A	11-36E737-107	BASE, HOUSING DRVR 12 TAURUS DUO INNER EDGE XLP BLACK
1	1	B	11-36E737-007	BASE, HOUSING PASS 12 TAURUS DUO INNER EDGE XLP BLACK
1	-	C	11-26E674-107	COVER, TOP DRVR 12 TAURUS DUO INNER EDGE XLP BLACK
1	1	D	11-26E674-007	COVER, TOP PASS 12 TAURUS DUO INNER EDGE XLP BLACK
1	-	E	07-287414-123	BRACKET, VISOR MT DRVR TAURUS INNER EDGE XLP BLACK
1	1	F	07-287414-023	BRACKET, VISOR MT PASS TAURUS INNER EDGE XLP BLACK
4	2	G	14-08228C-06D	SCREW, 8-32 X 3/8" PAN TORX HD ROLOK SS BLACK OXIDE

## 2013 - EXPLORER/SUV INTERCEPTOR

QTY	QTY	ITEM	PART NUMBER	DESCRIPTION
	*		01-0687688-21	FINAL, DUO INNER EDGE XLP, 6 LIGHT
*			01-0687688-22	FINAL, DUO INNER EDGE XLP, 12 LIGHT
1	-	A	11-36E300-107	BASE, HOUSING DRIVER BLACK 13 FORD SUV INNER EDGE XLP
1	1	B	11-36E300-007	BASE, HOUSING PASS BLACK 13 FORD SUV INNER EDGE XLP
1	-	C	11-26E741-107	COVER, TOP DRIVER BLACK 13 FORD SUV DUO INNER EDGE XLP
1	1	D	11-26E741-007	COVER, TOP PASS BLACK 13 FORD SUV DUO INNER EDGE XLP
1	-	E	07-287371-123	BRACKET, VISOR MT DRVR BLK 13 FORD SUV INNER EDGE XLP
1	1	F	07-287371-023	BRACKET, VISOR MT PASS BLK 13 FORD SUV INNER EDGE XLP
4	2	G	14-08228C-06D	SCREW, 8-32 X 3/8" PAN TORX HD ROLOK SS BLACK OXIDE

## 2013 - F150

QTY	QTY	ITEM	PART NUMBER	DESCRIPTION
	*		01-0687688-31	FINAL, DUO INNER EDGE XLP, 6 LIGHT
*			01-0687688-32	FINAL, DUO INNER EDGE XLP, 12 LIGHT
1	-	A	11-36E829-107	BASE, HOUSING DRVR 13 FORD F150 INNER EDGE XLP BLACK
1	1	B	11-36E829-007	BASE, HOUSING PASS 13 FORD F150 INNER EDGE XLP BLACK
1	-	C	11-26E834-107	COVER, TOP DRVR 13 FORD F-150 DUO INNER EDGE XLP BLACK
1	1	D	11-26E834-007	COVER, TOP PASS 13 FORD F-150 DUO INNER EDGE XLP BLACK
1	-	E	07-287501-123	BRACKET, VISOR MT DRVR 13 F150 INNER EDGE XLP BLACK
1	1	F	07-287501-023	BRACKET, VISOR MT PASS 13 F150 INNER EDGE XLP BLACK
4	2	G	14-08228C-06D	SCREW, 8-32 X 3/8" PAN TORX HD ROLOK SS BLACK OXIDE

## 2013 - F250-550

QTY	QTY	ITEM	PART NUMBER	DESCRIPTION
	*		01-0687688-41	FINAL, DUO INNER EDGE XLP, 6 LIGHT
*			01-0687688-42	FINAL, DUO INNER EDGE XLP, 12 LIGHT
1	-	A	11-36E848-107	BASE, HOUSING DRVR 13 F250/350 INNER EDGE XLP BLACK
1	1	B	11-36E848-007	BASE, HOUSING PASS 13 F250/350 INNER EDGE XLP BLACK
1	-	C	11-26E849-107	COVER, TOP DRVR 2013 F250/350 DUO INNER EDGE XLP BLACK
1	1	D	11-26E849-007	COVER, TOP PASS 2013 F250/350 DUO INNER EDGE XLP BLACK
1	-	E	07-287511-123	BRACKET, VISOR MT DRVR F250/350 INNER EDGE XLP BLACK
1	1	F	07-287511-023	BRACKET, VISOR MT PASS F250/350 INNER EDGE XLP BLACK
4	2	G	14-08228C-06D	SCREW, 8-32 X 3/8" PAN TORX HD ROLOK SS BLACK OXIDE

## 2018 - EXPEDITION

QTY	QTY	ITEM	PART NUMBER	DESCRIPTION
	*		01-0687688-F1	FINAL, DUO INNER EDGE XLP, 6 LIGHT
*			01-0687688-F2	FINAL, DUO INNER EDGE XLP, 12 LIGHT
1	-	A	11-36J151-107	BASE, HOUSING DRVR EXPEDITION INNER EDGE XLP BLACK
1	1	B	11-36J151-007	BASE, HOUSING PASS EXPEDITION INNER EDGE XLP BLACK
1	-	C	11-26J157-107	COVER, TOP DRVR '18 EXPEDITION WC INNER EDGE XLP BLACK
1	1	D	11-26J157-007	COVER, TOP PASS '18 EXPEDITION WC INNER EDGE XLP BLACK
1	-	E	07-288533-123	BRACKET, VISOR MT DS EXPEDITION INNER EDGE XLP BLACK
1	1	F	07-288533-023	BRACKET, VISOR MT PS EXPEDITION INNER EDGE XLP BLACK
4	2	G	14-08228C-06D	SCREW, 8-32 X 3/8" PAN TORX HD ROLOK SS BLACK OXIDE

## 2015 - F150

QTY	QTY	ITEM	PART NUMBER	DESCRIPTION
	*		01-0687688-E1	FINAL, DUO INNER EDGE XLP, 6 LIGHT
*			01-0687688-E2	FINAL, DUO INNER EDGE XLP, 12 LIGHT
1	-	A	11-36G373-107	BASE, HOUSING DRVR 15 FORD F150 INNER EDGE XLP BLACK
1	1	B	11-36G373-007	BASE, HOUSING PASS 15 FORD F150 INNER EDGE XLP BLACK
1	-	C	11-26G375-107	COVER, TOP DRVR 15 FORD F-150 DUO INNER EDGE XLP BLACK
1	1	D	11-26G375-007	COVER, TOP PASS 15 FORD F-150 DUO INNER EDGE XLP BLACK
1	-	E	07-287988-123	BRACKET, VISOR MT DRVR 15 F150 INNER EDGE XLP BLACK
1	1	F	07-287988-023	BRACKET, VISOR MT PASS 15 F150 INNER EDGE XLP BLACK
4	2	G	14-08228C-06D	SCREW, 8-32 X 3/8" PAN TORX HD ROLOK SS BLACK OXIDE

## 2020 - EXPLORER/SUV INTERCEPTOR

QTY	QTY	ITEM	PART NUMBER	DESCRIPTION
	*		01-0687688-H1	FINAL, DUO INNER EDGE XLP, 6 LIGHT
*			01-0687688-H2	FINAL, DUO INNER EDGE XLP, 12 LIGHT
1	-	A	11-36J428-107	BASE, HOUSING DRVR 2020 UTILITY INNER EDGE XLP BLACK
1	1	B	11-36J428-007	BASE, HOUSING PASS 2020 UTILITY INNER EDGE XLP BLACK
1	-	C	11-26J430-107	COVER, TOP DRVR 2020 UTILITY WC INNER EDGE XLP BLACK
1	1	D	11-26J430-007	COVER, TOP PASS 2020 UTILITY WC INNER EDGE XLP BLACK
1	-	E	07-288609-123	BRACKET, VISOR MT DRVR 2020 UTILITY INNER EDGE XLP BLACK
1	1	F	07-288609-023	BRACKET, VISOR MT PASS 2020 UTILITY INNER EDGE XLP BLACK
4	2	G	14-08228C-06D	SCREW, 8-32 X 3/8" PAN TORX HD ROLOK SS BLACK OXIDE

## 2013 - EXPEDITION

QTY	QTY	ITEM	PART NUMBER	DESCRIPTION
	*		01-0687688-51	FINAL, DUO INNER EDGE XLP, 6 LIGHT
*			01-0687688-52	FINAL, DUO INNER EDGE XLP, 12 LIGHT
1	-	A	11-36G031-107	BASE, HOUSING DRVR EXPEDITION INNER EDGE XLP BLACK
1	1	B	11-36G031-007	BASE, HOUSING PASS EXPEDITION INNER EDGE XLP BLACK
1	-	C	11-26G042-107	COVER, TOP DRVR 14 EXPEDITION DUO INNER EDGE XLP BLACK
1	1	D	11-26G042-007	COVER, TOP PASS 14 EXPEDITION DUO INNER EDGE XLP BLACK
1	-	E	07-287845-123	BRACKET, VISOR MT DRVR EXPEDITION INNER EDGE XLP BLACK
1	1	F	07-287845-023	BRACKET, VISOR MT PASS EXPEDITION INNER EDGE XLP BLACK
4	2	G	14-08228C-06D	SCREW, 8-32 X 3/8" PAN TORX HD ROLOK SS BLACK OXIDE

## 2013 - FUSION

QTY	QTY	ITEM	PART NUMBER	DESCRIPTION
	*		01-0687688-C1	FINAL, DUO INNER EDGE XLP, 6 LIGHT
*			01-0687688-C2	FINAL, DUO INNER EDGE XLP, 12 LIGHT
1	-	A	11-36E891-107	BASE, HOUSING DRVR 2013 FUSION INNER EDGE XLP BLACK
1	1	B	11-36E891-007	BASE, HOUSING PASS 2013 FUSION INNER EDGE XLP BLACK
1	-	C	11-26E925-107	COVER, TOP DRVR FORD FUSION DUO INNER EDGE XLP BLACK
1	1	D	11-26E925-007	COVER, TOP PASS FORD FUSION DUO INNER EDGE XLP BLACK
1	-	E	07-287529-123	BRACKET, VISOR MT DRVR FUSION INNER EDGE XLP BLACK
1	1	F	07-287529-023	BRACKET, VISOR MT PASS FUSION INNER EDGE XLP BLACK
2	1	G	21-12081205-3	SCREW GROMMET FASTEX #212-240602-040101
2	1	H	15-131416-202	SCREW, 1/4 X 1 1/4 PPHSMS SS TYPE A
2	1	I	15-081416-160	SCREW, 8 X 1 PPHSMS
4	2	J	14-08228C-06D	SCREW, 8-32 X 3/8" PAN TORX HD ROLOK SS BLACK OXIDE

# DODGE

## 2013 - CHARGER

QTY	QTY	ITEM	PART NUMBER	DESCRIPTION
	*		01-0687688-61	FINAL, DUO INNER EDGE XLP, 6 LIGHT
*			01-0687688-62	FINAL, DUO INNER EDGE XLP, 12 LIGHT
1	-	A	11-36E264-107	BASE, HOUSING DRVR 12 CHARGER INNER EDGE XLP BLACK
1	1	B	11-36E264-007	BASE, HOUSING PASS 12 CHARGER INNER EDGE XLP BLACK
1	-	C	11-26E670-107	COVER, TOP DRVR 12 CHARGER DUO INNER EDGE XLP BLACK
1	1	D	11-26E670-007	COVER, TOP PASS 12 CHARGER DUO INNER EDGE XLP BLACK
1	-	E	07-287356-123	BRACKET, VISOR MT DRVR CHARGER INNER EDGE XLP BLACK
1	1	F	07-287356-023	BRACKET, VISOR MT PASS CHARGER INNER EDGE XLP BLACK
4	2	G	14-08228C-06D	SCREW, 8-32 X 3/8" PAN TORX HD ROLOK SS BLACK OXIDE

## 2013 - RAM 1500

QTY	QTY	ITEM	PART NUMBER	DESCRIPTION
	*		01-0687688-71	FINAL, DUO INNER EDGE XLP, 6 LIGHT
*			01-0687688-72	FINAL, DUO INNER EDGE XLP, 12 LIGHT
1	-	A	11-36E862-107	BASE, HOUSING DRVR RAM 1500 INNER EDGE XLP BLACK
1	1	B	11-36E862-007	BASE, HOUSING PASS RAM 1500 INNER EDGE XLP BLACK
1	-	C	11-26E882-107	COVER, TOP DRVR DODGE RAM 1500 DUO INNER EDGE XLP BLACK
1	1	D	11-26E882-007	COVER, TOP PASS DODGE RAM 1500 DUO INNER EDGE XLP BLACK
1	-	E	07-287518-123	BRACKET, VISOR MT DRVR RAM 1500 INNER EDGE XLP BLACK
1	1	F	07-287518-023	BRACKET, VISOR MT PASS RAM 1500 INNER EDGE XLP BLACK
4	2	G	14-08228C-06D	SCREW, 8-32 X 3/8" PAN TORX HD ROLOK SS BLACK OXIDE
2	1	H	15-081416-160	SCREW, 8 X 1 PPHSMS

## 2013 - DURANGO

QTY	QTY	ITEM	PART NUMBER	DESCRIPTION
	*		01-0687688-81	FINAL, DUO INNER EDGE XLP, 6 LIGHT
*			01-0687688-82	FINAL, DUO INNER EDGE XLP, 12 LIGHT
1	-	A	11-36F186-107	BASE, HOUSING DRVR 13 DURANGO INNER EDGE XLP BLACK
1	1	B	11-36F186-007	BASE, HOUSING PASS 13 DURANGO INNER EDGE XLP BLACK
1	-	C	11-26F188-107	COVER, TOP DRVR DODGE DURANGO DUO INNER EDGE XLP BLACK
1	1	D	11-26F188-007	COVER, TOP PASS DODGE DURANGO DUO INNER EDGE XLP BLACK
1	-	E	07-287616-123	BRACKET, VISOR MT DRVR DURANGO INNER EDGE XLP BLACK
1	1	F	07-287616-023	BRACKET, VISOR MT PASS DURANGO INNER EDGE XLP BLACK
4	2	G	14-08228C-06D	SCREW, 8-32 X 3/8" PAN TORX HD ROLOK SS BLACK OXIDE

## 2019 - RAM 1500

QTY	QTY	ITEM	PART NUMBER	DESCRIPTION
	*		01-0687688-11	FINAL, DUO INNER EDGE XLP, 6 LIGHT
*			01-0687688-12	FINAL, DUO INNER EDGE XLP, 12 LIGHT
1	-	A	11-36J525-107	BASE, HOUSING DRVR 19 RAM 1500 INNER EDGE XLP
1	1	B	11-36J525-007	BASE, HOUSING PASS 19 RAM 1500 INNER EDGE XLP
1	-	C	11-26J524-107	COVER, TOP DRVR 2019 RAM 1500 INNER EDGE XLP
1	1	D	11-26J524-007	COVER, TOP PASS 2019 RAM 1500 INNER EDGE XLP
1	-	E	07-288641-123	BRACKET, VISOR MT DRVR 2019 RAM 1500 INNER EDGE XLP
1	1	F	07-288641-023	BRACKET, VISOR MT PASS 2019 RAM 1500 INNER EDGE XLP
4	2	G	14-08228C-06D	SCREW, 8-32 X 3/8" PAN TORX HD ROLOK SS BLACK OXIDE
2	1	I	15-081416-160	SCREW, 8 X 1 PPHSMS