

PROTECTING THOSE WHO PROTECT OTHERS

FIELD SERIES • WHELEN ENGINEERING COMPANY, INC.



FIELD SERIES™



THE ONLY BROW LIGHT THAT FEATURES
ALL-NEW REVOLUTIONARY DYNAMIC BEAM TECHNOLOGY

WHELEN
MANUFACTURED IN AMERICA

FIELD SERIES™

After months of gathering feedback from firefighters across the country, designing and manufacturing our latest innovation piece by piece, and meticulously testing designs in our optical labs and out in the field, we're proud to present you with the all-new Field Series™ Brow Light – the only brow light that illuminates your entire field of vision using our revolutionary dynamic beam technology to provide advanced control and maximum visibility with the flip of a switch.

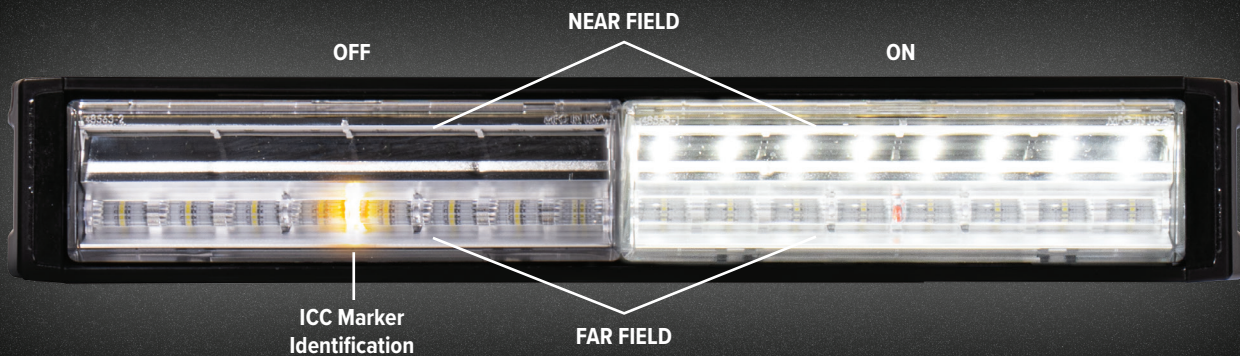

Engineer Kris Terpe works on our Field Series Brow Light to ensure it is optimized to safeguard first responders on every scene. His dedication and skill contribute to our mission to craft America's best products and helps to ensure our legacy of excellence endures.

WHELEN
MANUFACTURED IN AMERICA

WARNING: This product may contain chemicals known to the State of California to cause cancer and birth defects or other reproductive harm. For more information, visit whelen.com/regulatory.

**FIELD
SERIES™**

AMERICAN INNOVATION FROM START TO FINISH

When you show up at a scene, you follow protocol. You don't cut corners. You move with purpose and make sure the job is done right every time. So do we.

We don't launch a product until we're certain that it will be the best and safest asset for your critical missions. Because you deserve products that are designed and manufactured with the same intentionality and commitment to excellence that you show every single day.

The Field Series™ is a testament to our longstanding tradition of vertical integration with every step of the process being completed by our employees right here in America.

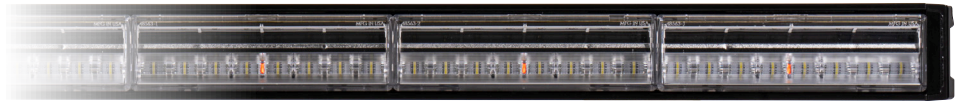

ENGINEERING

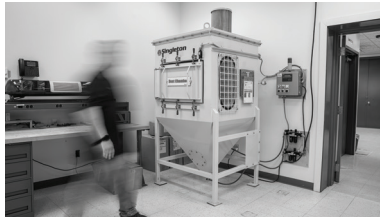

ENVIRONMENTAL TESTING



TOOLING

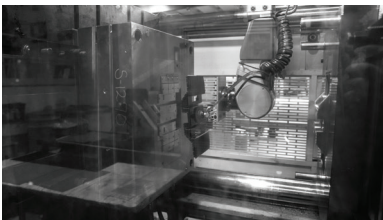

INJECTION & VACUUM MOLDING



FABRICATION



HARD-COATING



ASSEMBLY



QUALITY CONTROL & TESTING



LIFETIME WARRANTY

The Field Series™ is backed by our Lifetime Warranty. You can trust that your Field Series brow light will perform at the highest level in even the harshest conditions and feel secure in the knowledge that, no matter what happens, your purchase is covered for the entire lifetime of your apparatus. Ask your Whelen sales representative for more information on our lifetime warranty.

FIELD
SERIES™

 WARNING: This product may contain chemicals known to the State of California to cause cancer and birth defects or other reproductive harm. For more information, visit whelen.com/regulatory.

WHELEN[®]
MANUFACTURED IN AMERICA

ILLUMINATE YOUR **ENTIRE** FIELD OF VISION: REVOLUTIONARY BREAKTHROUGH OPTIC TECHNOLOGY

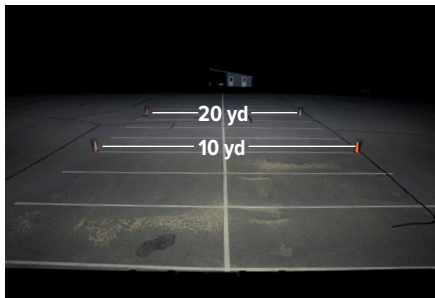

FAR FIELD

Light up the night with our Far Field optic technology that emits light in a wide and even spread at a greater distance than any other brow light on the market. You'll have full visibility of what lies ahead so you can act faster during critical missions when seconds count.

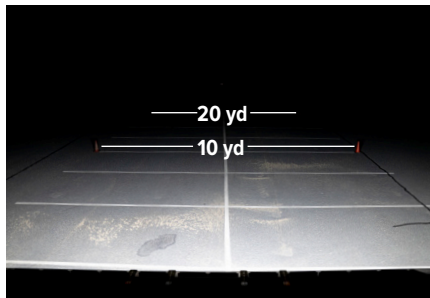

NEAR FIELD

Our Near Field optic technology directs the light spread down toward the ground providing precise illumination of the immediate area surrounding your apparatus. Operate with enhanced efficiency as you reach for the critical tools needed to get the job done.

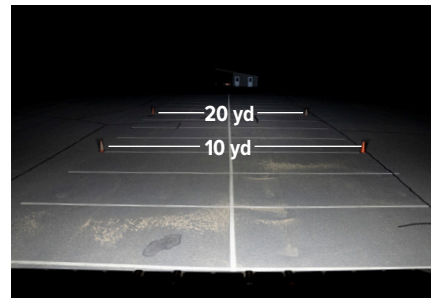

NEAR & FAR FIELD

Combine the precision of Near Field Optics with the depth of Far Field Optics for unmatched illumination that covers your entire field of vision. Combined optics allow you to maximize your efforts and stay safe on any scene.

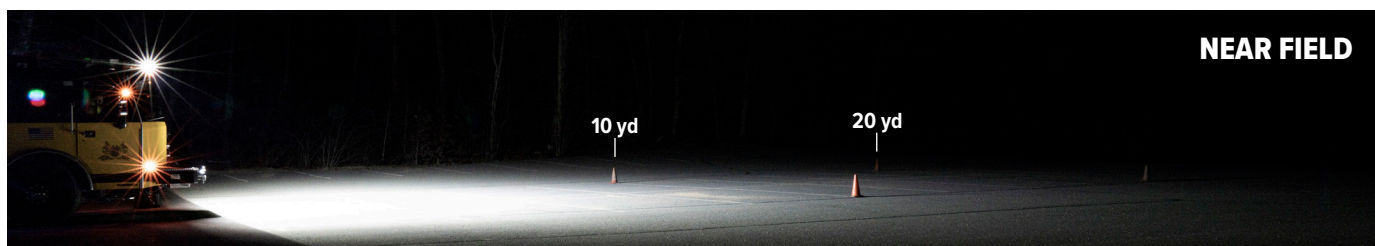



VARIABLE POWER DISTRIBUTION

Put the light where you need it, when you need it most with variable power distribution which allows you to dynamically adjust how both optic paths are powered – either Near, Far, or a combination of both depending on the needs of the moment.

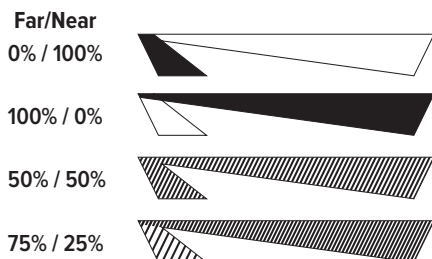

SELECTABLE TURN-ON FUNCTIONALITY

Much like our popular EZ Scene Lights™, the Field Series™ features multiple turn-on styles from instant to gradual that will allow you to use our brow light exactly as needed in any scenario.

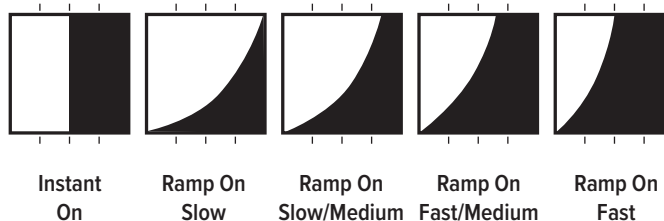

Model	Length	No. Lamps
FSB02B	13.82 in (35.1cm)	2-Lamp
FSB03B	20 in (50.8cm)	3-Lamp
FSB04B	26.1 in (66.3cm)	4-Lamp
FSB05B	32.2 in (81.8cm)	5-Lamp
FSB06B	38.4 in (97.5cm)	6-Lamp
FSB07B	44.5 in (113.1cm)	7-Lamp
FSB08B	60.6 in (153.9cm)	8-Lamp
FSB09B	56.7 in (144.1cm)	9-Lamp
FSB10B	62.9 in (159.8cm)	10-Lamp
FSB11B	69 in (175.3cm)	11-Lamp
FSB12B	75.1 in (190.8cm)	12-Lamp
FSB13B	81.3 in (206.5cm)	13-Lamp

Replace the Last "B" in the Model Number with "W" for a White Housing

Option	Description
FSBNFC	Combination Near/Far Field Lighthouse. No charge when purchased with a FSB array
FSBPS	Power Supply for up to 13 Lamps Total, with Scan-Lock™ Lighting Features and Low Power
FSBPC10	10' Power Supply Input Harness
FSBPC25	15' Power Supply Input Harness
FSBPC50	50' Power Supply Input Harness
FSBPC75	75' Power Supply Input Harness
FSBCC1	1' Interconnect Cable for Use with Two or Three Field Series Brow Light Arrays. One required for Two Light Array Solution and Two Required for Three Light Array Solutions. No charge when purchasing FSBPS.
FSBCC2	2' Interconnect Cable for Use with Two or Three Field Series Brow Light Arrays. One required for Two Light Array Solution and Two Required for Three Light Array Solutions. No charge when purchasing FSBPS.
FSBCC3	3' Interconnect Cable for Use with Two or Three Field Series Brow Light Arrays. One required for Two Light Array Solution and Two Required for Three Light Array Solutions. No charge when purchasing FSBPS.

SYSTEM CONFIGURATION

Single Stick*



Two Stick*



Three Stick*



*Max 13 modules per configuration

PRODUCT HOUSING COLOR OPTIONS

White



Black



FIELD
SERIES™

WARNING: This product may contain chemicals known to the State of California to cause cancer and birth defects or other reproductive harm. For more information, visit whelen.com/regulatory.

WHELEN
MANUFACTURED IN AMERICA

SERVICEABILITY

We understand how important it is to keep your rigs ready for a call, which is why the Field Series™ has been designed with serviceability in mind. Lighthouse modules are easily replaced within the overall structure of the brow light meaning there's no need to repurchase the entire unit just to replace a single module. And because the Field Series is backed by our Lifetime Warranty, replacements are covered for the entire lifetime of your apparatus.

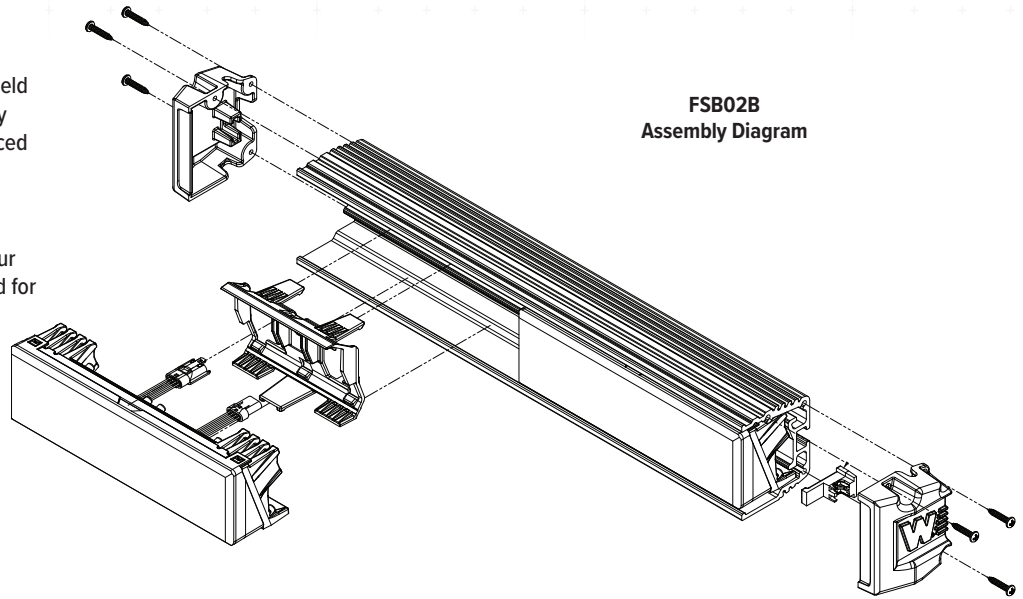

SPECS & FEATURES

- Up to 13 Modules per Power Supply in multiple configurations
- Field Serviceable
- 10-30 VDC
- 8 total inputs
- Low Current Switching
- Extruded aluminum Black or White powder-coated housing
- Hard-coated lenses
- Scan-Lock™

FSB02B	13.82 in (35.1cm)	2-Lamp
FSB03B	20 in (50.8cm)	3-Lamp
FSB04B	26.1 in (66.3cm)	4-Lamp
FSB05B	32.2 in (81.8cm)	5-Lamp
FSB06B	38.4 in (97.5cm)	6-Lamp
FSB07B	44.5 in (113.1cm)	7-Lamp
FSB08B	60.6 in (153.9cm)	8-Lamp
FSB09B	56.7 in (144.1cm)	9-Lamp
FSB10B	62.9 in (159.8cm)	10-Lamp
FSB11B	69 in (175.3cm)	11-Lamp
FSB12B	75.1 in (190.8cm)	12-Lamp
FSB13B	81.3 in (206.5cm)	13-Lamp

SINGLE STICK LENGTHS

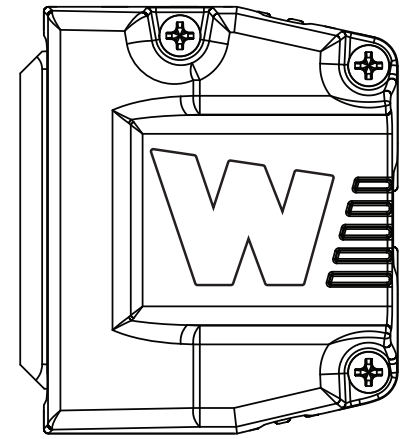

Field Series
Side Profile

DIMENSIONS

FSB02B 2-Lamp
Front View

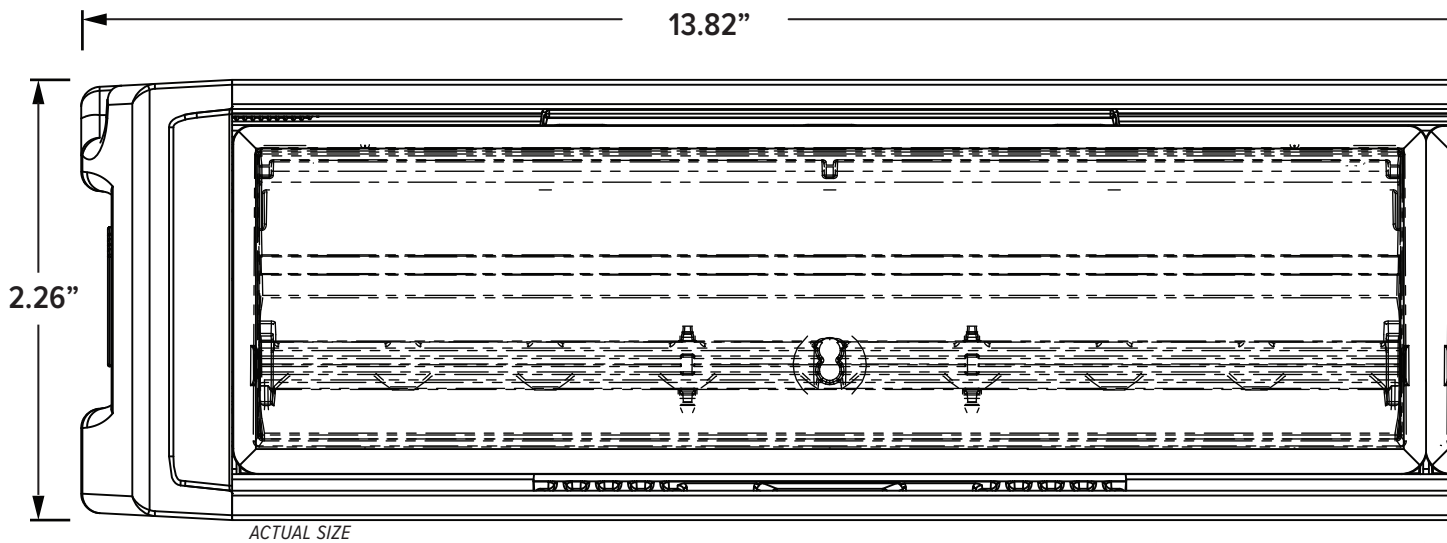

WHELEN
MANUFACTURED IN AMERICA

WARNING: This product may contain chemicals known to the State of California to cause cancer and birth defects or other reproductive harm. For more information, visit whelen.com/regulatory.

FIELD
SERIES™

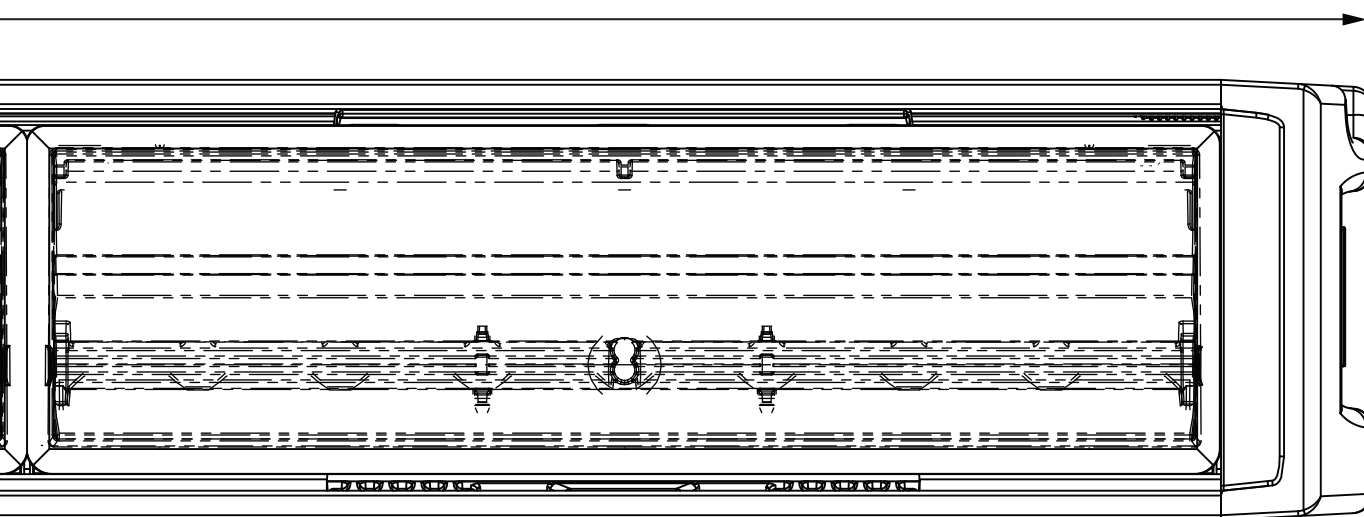
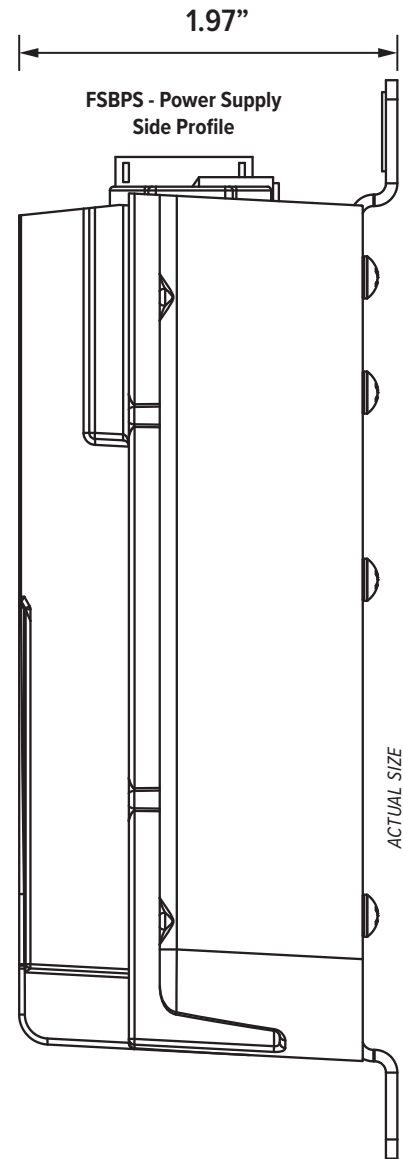
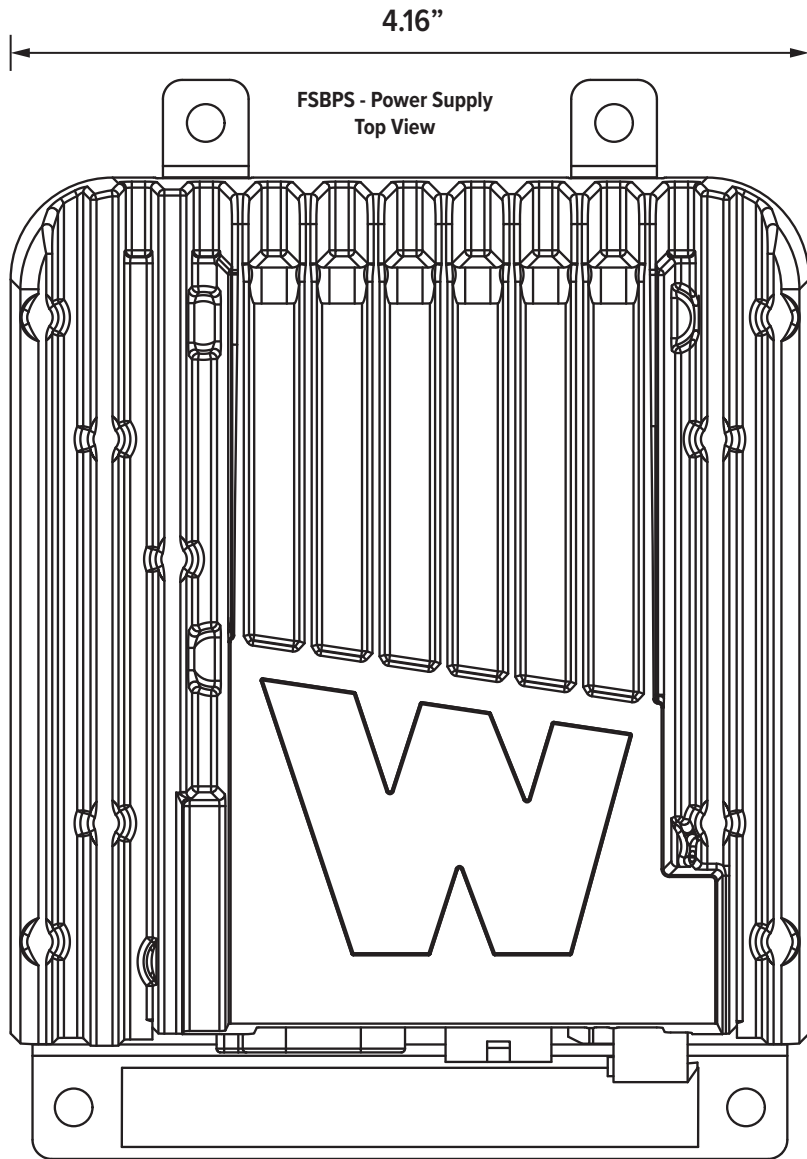

FIELD
SERIES™

 **WARNING:** This product may contain chemicals known to the State of California to cause cancer and birth defects or other reproductive harm. For more information, visit whelen.com/regulatory.

WHELEN®
MANUFACTURED IN AMERICA

PROTECTING THOSE WHO PROTECT OTHERS

FIELD SERIES™

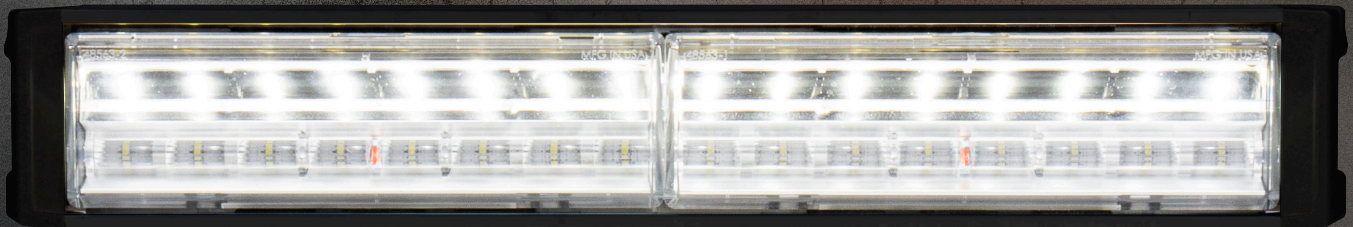

Trusted for more than 70 years to clear the way, illuminate
+ the scene, and send you home safe night after night to the +
ones you love. We never left and we're here to stay.

WHELEN[®]
MANUFACTURED IN AMERICA

www.whelen.com

@WhelenENG



NASCAR[™]
OFFICIAL WARNING LIGHTS

Preferred Warning Lights of



Whelen Engineering Company
(860) 526-9504
www.whelen.com

Whelen Engineering reserves the
right to upgrade and improve
products without notice.

© 2024 Whelen Engineering Company, Inc.
Printed in U.S.A.
Code No. B13492A - 03/2024

All products proudly designed, manufactured,
and assembled in the U.S.A.
• ISO 9001 Registered QMS